



# Economic feasibility of green hydrogen in providing flexibility to medium-voltage distribution grids in the presence of local-heat systems

Sina Ghaemi, Xinyu Li, Machiel Mulder <sup>\*,1</sup>

Faculty of Economics and Business, University of Groningen, 9747AE Groningen, The Netherlands

## ARTICLE INFO

### Keywords:

Green hydrogen  
Flexibility  
Medium voltage distribution grid  
Congestion  
Heat market

## ABSTRACT

The recent strong increase in the penetration of renewable energy sources (RESs) in medium-voltage distribution grids (MVDNs) has raised the need for congestion management in such grids, as they were not designed for this new condition. This paper examines to what extent producing green hydrogen through electrolyzers can profitably contribute to congestion alleviation in MVDNs in the presence of high amounts of RES, as well as flexible consumers of electricity and a local heat system. To address this issue, an incentive-based method for improving flexibility in MVDNs is used which is based on a single-leader–multiple-followers game formulated by bi-level mathematical programming. At the upper level, the distribution system operator, who is the leader of this game, determines dynamic prices as incentives at each node based on the levels of generation and load. Next, at the lower level, providers of flexibility, including producers using electrolyzers, price-responsive power consumers, heat consumers, as well as heat producers, respond to these incentives by reshaping their output and consumption patterns. The model is applied to a region in the North of The Netherlands. The obtained results demonstrate that converting power to hydrogen can be an economically efficient way to reduce congestion in MVDNs when there is a high amount of RES. However, the economic value of electrolyzers as providers of flexibility to MVDNs decreases when more other options for flexibility provision exist.

## 1. Introduction

Since a number of years, the installed capacity of decentralized renewable energy sources (RES) in European medium voltage distribution networks (MVDNs) is strongly increasing. For the near future, an even stronger growth is expected. Such a significant growth in the RES penetration level can cause congestion problems as these networks have not been designed for this situation [1]. These problems occur when security constraints are violated. These constraints refer to the maximum permissible amount for passing power through each line and the permissible bound for the voltage level of each node. Apart from the effect of the high integration level of RES, this problem can worsen once more electrical consumers with correlated demand pattern such as electric vehicles are connected to the grid. Therefore, it is necessary to find an appropriate solution for dealing with these congestion problems.

Upgrading distribution grids to increase existing lines' capacity is one solution to address these problems. This is, however, a long-term and costly option. For the short-term, various other methods are

available, which can be divided into two main categories: 1) network options and 2) instruments for reshaping grid users' generation and consumption patterns [2]. Network options include reconfiguration of the grid, voltage regulation, and reactive power management. The second category includes the use of financial instruments to encourage grid users to utilize so-called distributed flexibility resources (DFRs), such as electric vehicles, energy storage, and price-responsive loads [3]. Our paper analyzes the use of such financial instruments by grid operators.

Several studies have attempted to evaluate to what extent DFRs can successfully alleviate congestion in grids [4]. In these studies, the role of producing green hydrogen in providing flexibility in MVDNs has not yet been fully considered. As governments are increasingly considering the use of hydrogen as renewable-energy carrier, it has become more relevant to analyze the potential role of electrolysis as provider of flexibility to MVDNs. The contribution of this paper is that it extensively addresses this issue, taking into account various other potential sources of flexibility such as flexible heat production.

\* Corresponding author.

E-mail address: [machiel.mulder@rug.nl](mailto:machiel.mulder@rug.nl) (M. Mulder).

<sup>1</sup> The authors thank the audience of SuperP2G Consortia Workshops, the members of the national sounding board, the colleagues from the Centre for Energy Economics Research, and two anonymous reviewers for their useful suggestions and feedback. This project was funded by NWO, Netherlands under the title "Synergies Utilising renewable Power Regionally by means of Power To Gas" as part of the ERA-Net Plus Smart Grids Call 2018. Of course, the authors remain responsible for any remaining shortcoming.

## Nomenclature

### Indices

$t$	Index for dispatch time
$l$	Index for branch (line)
$n$	Index for busbar
Elz	Abbreviation for electrolyzer
Chp	Abbreviation for CHP unit
EB	Abbreviation for electrical boiler
GB	Abbreviation for gas boiler
HB	Abbreviation for hydrogen boiler
HS	Abbreviation for heat storage

### Parameters

$p^{H_2}, p^{Gas}, p^{Carb}, p^{H_2O}$	Hydrogen, gas, carbon, and water consumption price
$p^{loss}, p^{shed}, p^{Curt}$	Energy loss, load shedding, and generation curtailment price
$p^{block}_k$	Marginal benefit of consumer at block $k$
$p^{O\&M}_{EB}, p^{O\&M}_{GB}, p^{O\&M}_{HB}$	O&M cost of electrical boiler, gas boiler, and hydrogen boiler
$p^{O\&M}_{Chp}, p^{O\&M}_{HS}$	O&M cost of combined heat and power (CHP) unit and heat storage
$Q^{Cap}_{Chp}$	Installed capacity of electrolyzer
$Q^{Cap}_{HS}$	Installed capacity of heat storage
$Q^{min}_{Chp}, Q^{max}_{Chp}$	Minimum and maximum power generation of CHP unit
$Q^{min}_{EB}, Q^{max}_{EB}$	Minimum and maximum heat power generation of electrical boiler
$Q^{min}_{GB}, Q^{max}_{GB}$	Minimum and maximum heat power generation of gas boiler
$Q^{min}_{HB}, Q^{max}_{HB}$	Minimum and maximum heat power generation of hydrogen boiler
$Q^{min}_{load}, Q^{max}_{load}$	Minimum and maximum electrical power consumption of consumer
$Q^{Exp}_{RW}$	Expected power generation of renewable source
$\alpha_t, \beta_t$	Intercept and slope of inverse demand function
$S^{max}$	Maximum thermal capacity of line
$SOC^{HS}_{min}, SOC^{HS}_{max}, SOC^{HS}_{initial}$	Minimum, maximum, and initial energy level of heat storage
$R_{line}, X_{line}$	Resistance and reactance of the line
$\cos(\phi)$	Power factor of electrical load
$\eta^{Elz}, \eta^{EB}, \eta^{GB}, \eta^{HB}, \eta^{HS}_{ch,dch}$	Efficiency of electrolyzer, electric boiler, gas boiler, hydrogen boiler, and heat storage charging and discharging rate
$\eta^{Chp}, \eta^{P2Heat}, \eta^{Carb}$	Electric efficiency, power to heat ratio, and coefficient of generated carbon of CHP unit
$Ramp^{Up,Down}$	Ramp up and down amount of the particular technology
$\Delta t$	Dispatch interval (1 h)

The reason we include a local heat system is that heat is increasingly produced by using electricity, and as heat can be stored, it can also provide flexibility. Hence, this paper seeks to evaluate to what extent producing green hydrogen can profitably increase the ability of medium voltage grids to deal with congestion problems resulting from high levels of renewables in the presence of various other flexible sources.

### Sets

$\tilde{h}(n)$	Set of grid lines located after the bus $n$
$back(n)$	Set of grid lines that the node $n$ is their receiving-end node
$ahead(n)$	Set of grid lines that the node $n$ is their sending-end node

### Variables

$p^{Elc}$	Electrical price at node $n$
$p^{Heat}$	Heat price
$Q^{Elz,E}, Q^{Elz,H}$	Electrolyzer's consumed power, produced hydrogen
$Q^{Chp,E}, Q^{Chp,heat}$	CHP unit's generated electric power and heat power
$Q^{Gas}_{Chp}, Q^{Carb}_{Chp}$	Consumed natural gas, and generated carbon emission of CHP unit
$Q^{EB,E}, Q^{EB,Heat}$	Electric boiler's consumed power and generated heat
$Q^{Gas}_{GB}, Q^{Carb}_{GB}, Q^{Heat}_{GB}$	Gas boiler's consumed natural gas, generated carbon emission, and generated heat power
$Q^{H_2}_{HB}, Q^{Heat}_{HB}$	Hydrogen boiler's consumed hydrogen, generated heat
$Q^{HS}_{ch}, Q^{HS}_{dch}$	Absorbed and injected heat power of heat storage
$Q^{Load,E}, Q^{block}_k$	Electrical consumer's total demanded power, and power at block $k$
$Q^{Load}_{shed}, Q^{Elz}_{shed}, Q^{P2Heat}_{shed}$	Shedded power of electric consumer, electrolyzer, and electrical boiler
$Q^{Curt}_{Chp}, Q^{RW}_{Curt}$	Curtailment power of CHP unit, and renewable resource
$Q^{Load}_{grid}, Q^{Elz}_{grid}, Q^{P2Heat}_{grid}$	Actual absorbed power of electrical consumer, electrolyzer and electrical boiler from the grid
$Q^{Chp}, Q^{RW}, Q^{gen}$	Injected power of CHP unit, renewable resource, and upstream grid
$Q^{Line}, q^{Line}, Q^{Loss}$	Active and reactive power of line, and active power loss
$Q^{Cons}_{Cload}, q^{load}, q^{gen}$	Total Consumed heat power Consumed reactive power of load, and generated reactive power of upstream
$S^{Line}$	Apparent power of line
$SOC^{HS}$	Energy level of heat storage.
$V$	Voltage magnitude of node
$[\chi_{n,t}^{Elz,1} \dots \chi_{n,t}^{Elz,4}]$	Dual variables associated with operational electrolyzer's constraints
$[\chi_{n,t}^{Load,1} \dots \chi_{n,t}^{Load,3}]$	Dual variables associated with operational price responsive load's constraints
$[\chi_{n,t}^{Chp,1} \dots \chi_{n,t}^{Chp,6}]$	Dual variables associated with operational constraints of CHP unit
$[\chi_{n,t}^{EB,1} \dots \chi_{n,t}^{EB,4}]$	Dual variables associated with operational constraints of electrical boiler
$[\chi_{n,t}^{GB,1} \dots \chi_{n,t}^{GB,4}]$	Dual variables associated with operational constraints of gas boiler
$[\chi_{n,t}^{HB,1} \dots \chi_{n,t}^{HB,4}]$	Dual variables associated with operational constraints of hydrogen boiler

To fulfill this aim, a single-leader-multiple-followers game is developed. In this method, for every time unit dynamic congestion prices are determined for every node in a grid by the leader (i.e. the grid

$[\chi_{n,t}^{Hs,1} \dots \chi_{n,t}^{Hs,5}]$	Dual variables associated with operational constraints of heat storage
$[\lambda_{n,t}, \phi_{n,t}, \gamma_{l,t}]$	Power flow problem: dual variables associated with constraints (39)–(41)
$[\psi_{n,t}^{Load,Q}, \psi_{n,t}^{Load,q}]$	Power flow problem: dual variables associated with constraints (42)–(43)
$[\psi_{n,t}^{Elz}, \psi_{n,t}^{P2Heat}]$	Power flow problem: dual variables associated with constraints (44)–(45)
$[\psi_{n,t}^{Chp}, \psi_{n,t}^{RW}, v_{n,t}^-, v_{n,t}^+]$	Power flow problem: dual variables associated with constraints (46)–(48)
$[\omega_{l,t}^1 \dots \omega_{l,t}^4]$	Power flow problem: dual variables associated with constraints (50)–(53)

operator), and in response the followers (i.e. various price-responsive agents) adapt their production or consumption of electricity in order to maximize their objective functions (which generally consist of cost minimization). Using this model, the economic value of electrolysis as provider of grid flexibility is calculated. Applying our model to a region in the North of the Netherlands, we find that to make investments in electrolysis in distribution systems profitable, high levels of RES are required, and this holds even stronger when other flexibility providers exist, such as those coming from a local heat system.

The outline of this paper is as follows. Section 2 discusses the literature. Section 3 presents our mathematical model. We apply this model to a region in the Netherlands, which case study is described in 4. Section 5 describes the results and Section 6 presents our conclusions.

## 2. Literature review

A considerable amount of literature has been recently published on congestion management in distribution networks due to the increasing integration level of renewables and consumers with correlated pattern demands in such grids. This section is set up to review the most important of them.

Yan et al. in [5] have investigated the technical efficiency of energy storage in reducing congestion and peak shaving in distribution grids through the robust optimization problem. According to their findings, the DSO can use energy storage as a supportive tool to increase the grid's flexibility and defer the grid's upgrading. Bai et al. in [6] have utilized distribution locational marginal price as a price signal for motivating owners of electrical energy storage, load aggregators, and operators of microgrids to contribute to reducing grid congestion. In addition, Jafarian et al. in [7] have demonstrated that a combined uniform and nodal pricing as a price signal reduce congestion and maximize social welfare in distribution networks considering electrical energy storage. The frequent reconfiguration of the grid as a network option for solving congestion in distribution grids might cause high maintenance and operation costs along with fast degradation of the grid's circuit breakers. To avoid high application of grid reconfiguration, co-optimization of electrical energy storage and reconfiguration of grid topology has been adopted in [8] for dealing with the congestion problem in those grids. Results in [8] declared that the proposed approach resulted in less generation curtailment despite that the frequency of the reconfiguration has been dramatically dropped.

A decentralized local flexible market has been considered in [9] for efficiently solving the congestion problem of distribution grids. In this framework, electric vehicles and heat pumps are considered flexible sources for providing flexibility in such grids. In the developed market, it has been evaluated how flexibility provided by electric vehicles can reduce grid congestion efficiently. Results showed that aggregators and consumers could make a profit in this market along with a positive effect on reducing congestion in the grid. Asrari et al. in [10] have

developed a day-ahead market platform for alleviating congestion in distribution grids. They concluded that collaboration among EV aggregators diminishes congestion in the grid without the administrative support of the network operator. Zhao et al. in [11] have analyzed the effectiveness of proposing distribution locational marginal price as a price incentive for activating flexible loads like electric vehicles to reduce congestion problems in distribution grids. In addition, in [11], the soft open point as a new power electronic device is used for solving congestion problems as a network option. They showed that applying both an immediate solution by power electronic devices and an indirect one through proposing incentives can improve flexibility in distribution grids in case of high integration levels of EVs. Deb et al. in [12] have proposed a coordinated strategy for power trading among electric vehicles and the grid to lead to fewer congestion problems in the distribution grid. They verified that the security constraints of the grid could not be violated in the considered case study by 800 electric vehicles once the proposed coordinated strategy is applied. Finally, Venegas et al. in [13] have reviewed various scientific literature about how technically electric vehicles can provide flexibility in distribution grids along with existing barriers.

A local flexibility market has been developed in [14] for reducing congestion in distribution grids. Indeed, the mentioned market empowered the grid's consumers towards providing the grid's required up and down-regulation flexibility. Implementation of this market in distribution grids in Spain showed that activating consumers through this market can reduce the generation curtailment of PV systems in such grids. The effectiveness of demand response in improving the distribution grid's flexibility has been addressed in [15]. A two-tier scheme that includes flexible demand swap and market control has been proposed to aim this. In addition, the active consumers' willingness to supply flexibility for the grid has been calculated through the proposed control in this scheme. According to the obtained results, the grid's congestion can be solved efficiently based on this scheme, and the consumers can rebound energy during various periods. Huang et al. in [16] have analyzed how dynamic subsidy calculated by the distribution system operator can shift consumers' energy consumption in a way that leads to solving the congestion problem in the grid. They demonstrated that the proposed method provides an economical energy price for the consumers and has no rebound effect. Liu et al. in [17] have utilized distribution congestion price as a price signal to motivate household consumers to reshape their consumption pattern in a way that leads to fewer congestion problems. Although the implementation of this approach was positive in reducing the grid congestion, it failed to solve it completely. Steriotis et al. in [18] have suggested the behavioral real-time pricing mechanism for promoting end-users to provide flexibility in distribution grids. The introduced pricing mechanism in [18] also covered the drawbacks of the conventional real-time pricing mechanism. Shen et al. in [19] have studied the advantages of simultaneously applying dynamic tariff, grid reconfiguration, and re-profiling products to improve the flexibility in the distribution grids with high integration levels of distributed energy resources. They demonstrated that the proposed scheme could use the flexibility of electric vehicles and heat pumps to reduce grid congestion without facing consumers with higher dynamic tariffs.

Hu et al. in [20] have assessed the effect of multiple energy complementarity of energy hubs comprised of combined cooling–heating–power units and heat pumps on reducing congestion of distribution grids. Results in [20] illustrated that the complementarity of power, heat and cooling energy based on the optimal operation strategy could effectively reduce the congestion problem in distribution grids and provide more capacity for renewables integration. Luo et al. in [21] have proposed a two-stage hierarchical congestion management approach that includes both direct and indirect solutions for empowering local distributed energy resources toward providing flexibility for distribution grids. Results revealed that the proposed approach could reduce the congestion cost of the grid and increase the grid's flexibility in

accommodating more renewables. Dehkordi et al. in [22] have implemented an incentive-based mechanism to motivate distributed flexible sources such as batteries and price-responsive loads toward reducing the congestion in distribution grids. In addition, grid reconfiguration has also been considered one network option for DSO to mitigate congestion problems in the grid. Zhang et al. in [23] have established a local flexibility market named FLECH in Danish distribution grids for mitigating grid congestion due to the high penetration level of renewables. In this market, owners of distributed flexible resources can contribute to providing ancillary services for DSO to make more profit. Likewise, Geschermann et al. in [24] have assessed the suitability of developing the local market for empowering DFRs towards providing flexibility in German distribution grids. Grid congestion management controller has been presented in [25] for controlling directly active power of distributed energy resources such as batteries, distributed generators, and loads for dealing with congestion problems in the distribution grid. This innovative controller comprises two main parts, namely congestion assessment and congestion management seeks to maintain grid stability through adjusting the output power of DFRs. Contreras et al. in [26] have proposed a quota-based method for limiting the maximum feed-in power of producers and consumption level of consumers to reduce congestion in the distribution grids. This method can be helpful for distribution grids that suffer from inadequate reactive power compensation equipment.

As seen, most studies have only focused on motivating local distributed flexible resources such as electric vehicles, heat pumps, batteries, and end customers to contribute to improving distribution grids' flexibility through different congestion management methods. However, emerging power to gas conversion systems can also bring various opportunities for energy systems such as flexibility [27] and decarbonization [28]. Therefore, assessing how these technologies can be an economically efficient solution for energy systems is necessary. Xiong et al. in [29] have only studied the technical suitability of installing power to gas conversion systems in German electrical systems for improving flexibility. They demonstrated that converting power to synthetic natural gas can reduce 12% of generation curtailment once such systems are only installed on a small set of buses with frequent generation curtailment. However, the economic feasibility of such devices has not been addressed in that paper. Technical and economic assessment of linking power to gas conversion system to the 50 MW wind turbine has been done in [30]. According to this paper's considered assumptions, installing such a conversion system cannot be cost-effective without receiving supportive schemes. Qadrdan et al. in [31] have assessed how technically converting power to hydrogen can provide flexibility for Britain's integrated gas and electrical systems. They demonstrated that the produced hydrogen could reduce the generation curtailment of the wind turbine in case of high feed-in and decrease the overall operation cost of the integrated energy system. Corato et al. in [32] have developed a model to assess the aggregated flexibility provided by power to gas conversion systems in distribution grids considering both electricity and gas network constraints. That study demonstrates that such conversion systems are overestimated in terms of their contribution to grid flexibility if gas network constraints are skipped. Henni et al. in [33] have assessed the effectiveness of sector coupling between distribution grid and gas network via power-to-gas conversion systems on reducing the generation curtailment in the electrical grid. In order to achieve this goal, this paper uses a geographical-information system to identify areas of the electrical grid that are most likely to become congested in the future because of high levels of renewable-energy integration. In those areas, they place P2G systems. Likewise, the technical suitability of installing power to gas conversion systems in distribution grids to reduce overloading and reverse power flow has been assessed in [34]. However, the economic analysis has not been considered. Robinius et al. in [35] compared two options for dealing with surplus generation in distribution grids, which are installing electrolyzers and expanding the grid capacity. They

concluded that the costs of grid expansion can be significantly reduced when it is combined with installing electrolyzers. Jaramillo et al. in [36] suggested a mixed integer linear program to optimize a micro-grid with power-to-gas conversion systems in order to reduce peak load. It was seen that aside from the ability of such systems to store energy on a long-term basis, they are appreciated for their ability to convert power to hydrogen. El-Taweel et al. in [37], evaluating the effect of power-to-gas conversion systems on voltage regulation of distribution grids considering the technical constraints of gas networks, defined two new indices to achieve this goal. Yue et al. in [38] have done a massive literature review on the existing trends and challenges in developing energy systems that can be powered by hydrogen. According to their review, one of the essential aspects of expanding hydrogen-powered systems is how expenditure costs can be recovered. They concluded that supportive schemes are demanded to enable hydrogen as a cost-effective energy carrier.

According to the reviewed articles, what is not yet clear is the economic value of electrolysis as provider of flexibility to medium-voltage distribution grids. This gap is completely fulfilled in this paper. As known, a break-even point of electrolyzer can be sensitive to the number of flexibility providers in the medium voltage distribution grids. Due to the advent of technologies that can provide sector coupling between electrical grids and heat networks and price-responsive loads, the number of flexibility providers in distribution grids has risen. Therefore, in-depth economic analysis is demanded to verify how installing electrolyzer in medium voltage distribution grids can be a competitive solution considering flexibility impact of other grid users. This issue is critically examined in the rest of this paper.

### 3. Method of research

We analyze the economic value of electrolysis as supplier of flexibility to a medium-voltage grid by developing and applying a model simulating a local distribution grid with high shares of renewables (both wind and solar PV), price-responsive consumers and a connection to a local-heat system with heat produced through combined heat and power (CHP) units, electrical, gas and hydrogen boilers, as well as heat pumps (see Fig. 1). In this Section, we first present the analytical framework of the model (Section 3.1), and afterwards we present the mathematical formulation (Section 3.2).

#### 3.1. Model framework

Our model is meant to evaluate the economic value of electrolyzers providing flexibility to a medium-voltage distribution grid in order solve congestion which arises from high levels of renewable generation and/or load. The renewable generation comes from wind turbines and photovoltaic systems, which both are treated exogenously, which means that this generation only depends on external (weather) circumstances. The electricity load comes from electricity consumers and electrolyzers. Both types of consumers are considered to be price sensitive, which means that they are able to provide flexibility to the grid, provided that the grid operator gives them financial incentives. The price which is faced by the electricity consumers is based on the short-term (day-ahead) wholesale electricity price, which is treated exogenously, and the dynamic congestion price, which is endogenously determined by the grid operator. In order to so, the grid operator minimizes its overall costs which results in a scarcity price of grid capacity in case grid constraints are threatened. This means that in case of congestion due to overproduction, the overall electricity price is lowered because of a negative congestion price, which results in an incentive to consumers, including electrolyzers to raise their electricity consumption. Hence, the more congestion due to renewable generation, the lower the electricity price, the higher the economic value of electrolyzers. As the distribution grid consists of several nodes, the electricity production technologies and load appliances are placed at

different grid nodes and consequently they have different effects on the optimal operation of the grid. Hence, the above congestion prices are also determined per node, which makes that we apply a nodal pricing scheme. This means that the electricity price for network users can differ among nodes depending on the presence and degree of congestion and network loss in the various nodes.

We apply our model to a medium-voltage distribution grid which has a connection with a local decentralized heat system. The reason for implementing this linkage between the power grid and a heat system is that the latter can provide flexibility to the former. As a result, this source of flexibility needs to be taken into account when one wants to evaluate the economic value of one particular type of flexibility, which is in our case hydrogen production by electrolysis. In the heat system, we include the following technologies which are directly connected to the electricity grid as well: CHP unit, electrical boiler, and heat pump. It is clear that the CHP unit is an additional potential producer of electricity, next to the renewable producers, while the electrical boiler and the heat pump are additional consumers. These extra players affect the presence and size of congestion and, hence, the congestion prices. Consequently, they also affect the economic value of electrolyzers to provide flexibility to the grid. In addition, the heat system also include gas boilers and hydrogen boilers. For both types of heat producers, we use exogenous values of their fuel prices (gas and hydrogen, respectively). Together, these heat-producing technologies constitute the supply side of the heat market. This market is operated by an operator which has an objective to clear the market by determining the equilibrium heat price. In order to do this, this market operator also receives information from heat consumers about their willingness to pay for heat. Both the supply side and the demand side of the heat market also include a heat-storage operator, which supplies or demands heat depending on the heat price. All these various players in the heat market affect the heat price and, consequently, the optimal decisions for those agents that are also connected to the distribution grid. Hence, the decisions taken in the heat market also affect the economic value of electrolyzers as providers of flexibility to the grid.

Note that our model is directed at the interval between the closure of the day-ahead market and real-time. The re-dispatch approach is performed after day-ahead market clearing for electricity, hydrogen, and gas. Hence, as said, the prices for these energy carriers are treated exogenously.

Technically, the model is a single-leader-multiple-followers game. In this game, followers believe that the leader's incentives (i.e. the nodal prices) are exogenous and firm. In addition, the game leader updates the incentives according to the followers' reactions. In this model, the DNO plays a leadership role while the grid's users are followers (See Fig. 2).

### 3.2. Mathematical model

In this subsection, a mathematical optimization problem for each grid user is provided. After that, we describe how the local-heat market is modeled and cleared.

#### 3.2.1. Producers using electrolyzers (Power-to-Hydrogen conversion system)

Power-to-Hydrogen conversion systems can split water into oxygen and hydrogen by consuming electrical power. These technologies can be a source of flexibility to reduce congestion in the grid in case of high integration level of renewables. Therefore, to evaluate their economic value as provider of flexibility, it is assumed that such conversion systems have been placed at the nodes with the highest generation curtailment. The optimization problem of a producer, taking into account the relevant technical constraints, is to minimize the net costs aggregated over a full day:

$$\text{O.F. : } \min_{\{Q_{n,t}^{Elz,E}, Q_{n,t}^{Elz,H}\}} \sum_{t=1} Q_{n,t}^{Elz,E} P_{n,t}^{Elc} + \sum_{t=1} Q_{n,t}^{Elz,H} P_t^{H_2O} - \sum_{t=1} Q_{n,t}^{Elz,H} P_t^{H_2} \quad (1)$$

$$Q_{n,t}^{Elz,E} = Q_{n,t}^{Elz,H} / \eta_{Elz,n} : \chi_{n,t}^{Elz,1} \quad (2)$$

$$0 \leq Q_{n,t}^{Elz,H} \leq Q_n^{Cap} : \chi_{n,t}^{Elz,2^-} : \chi_{n,t}^{Elz,2^+} \quad (3)$$

$$Q_{n,t}^{Elz,H} - Q_{n,t-1}^{Elz,H} \leq \text{Ramp}_{Elz}^{Up} \Delta t : \chi_{n,t}^{Elz,3} \quad (4)$$

$$Q_{n,t-1}^{Elz,H} - Q_{n,t}^{Elz,H} \leq \text{Ramp}_{Elz}^{Down} \Delta t : \chi_{n,t}^{Elz,4} \quad (5)$$

The objective function comprises three terms. The first term refers to the cost of buying electrical power from the grid. The second one shows the cost of water consumption. Finally, the last term demonstrates the revenue from selling the green hydrogen. The amount of consumed electric power at each hour is shown in Eq. (2). The maximum permissible amount for producing hydrogen is limited through Eq. (3). In addition, Eqs. (4) and (5) emphasize the ramp-up and ramp-down limitations of the electrolyzer.

#### 3.2.2. Price responsive electrical consumer

Price-responsive electrical consumers prefer to pay different prices at different energy amounts. To consider this characteristic of consumers, their benefit function includes  $k$  blocks. The coefficient associated with each block shows the marginal benefit of consuming electrical power at that particular block for the consumer. Concerning the consumer's price elasticity, this benefit function has been formulated by a piece-wise linear function. Hence, the mathematical optimization problem of the price-responsive consumer at node  $n$  can be constructed as follows:

$$\text{O.F. : } \min_{\{Q_{n,k,t}^{block}, Q_{n,t}^{Load,E}\}} \sum_{t=1} \sum_{k=1} (P_{n,t}^{Elc} - P_{n,k,t}^{block}) Q_{n,k,t}^{block} \quad (6)$$

$$Q_{n,t}^{Load,E} = \sum_k Q_{n,k,t}^{block} : \chi_{n,t}^{Load,1} \quad (7)$$

$$Q_{load,n,t}^{min} \leq Q_{n,t}^{Load,E} \leq Q_{load,n,t}^{max} : \chi_{n,t}^{Load,2^-}, \chi_{n,t}^{Load,2^+} \quad (8)$$

$$Q_{load,n,k,t}^{min} \leq Q_{n,k,t}^{block} \leq Q_{load,n,k,t}^{max} : \chi_{n,t}^{Load,3^-}, \chi_{n,t}^{Load,3^+} \quad (9)$$

As seen in Eq. (6), the objective function includes the aggregated net cost of the consumers originating from buying electrical power from the grid over a full day. Eq. (7) presents the total consumption level of a consumer at time  $t$ . Eq. (8) shows the permissible bound for energy consumption level of the consumer. Finally, the last equation highlights that the energy consumption level at each block cannot exceed its predefined maximum level.

#### 3.2.3. Combined heat and power (CHP) producers

The producers using CHP units are assumed to use a gas turbine as a prime mover, which means that it consumes natural gas as the primary fuel and generates electricity and heat power through its generator and heat recovery unit. The optimization problem of the producers using this technology is to minimize the net costs aggregated over a full day considering its operational constraints:

$$\text{O.F. : } \min_{\{Q_{Chp,n,t}^{Gas}, Q_{Chp,n,t}^{Carb}, Q_{Chp,n,t}^{Chp,E}, Q_{n,t}^{Chp,Heat}\}} \sum_{t=1} Q_{Chp,n,t}^{Gas} P_t^{Gas} + \sum_{t=1} Q_{Chp,n,t}^{Carb} P_t^{Carb} + \sum_{t=1} Q_{Chp,n,t}^{Chp,E} P_{Chp,t}^{O\&M} - \sum_{t=1} Q_{Chp,n,t}^{Chp,E} P_{n,t}^{Elc} - \sum_{t=1} Q_{Chp,n,t}^{Heat} P_t^{Heat} \quad (10)$$

$$Q_{n,t}^{Gas} = Q_{n,t}^{Chp,E} / \eta_n^{Chp} : \chi_{n,t}^{Chp,1} \quad (11)$$

$$Q_{n,t}^{Carb} = \eta_n^{Carb} Q_{n,t}^{Gas} : \chi_{n,t}^{Chp,2} \quad (12)$$

$$Q_{n,t}^{Chp,Heat} = \eta_n^{p2Heat} Q_{n,t}^{Chp,E} : \chi_{n,t}^{Chp,3} \quad (13)$$

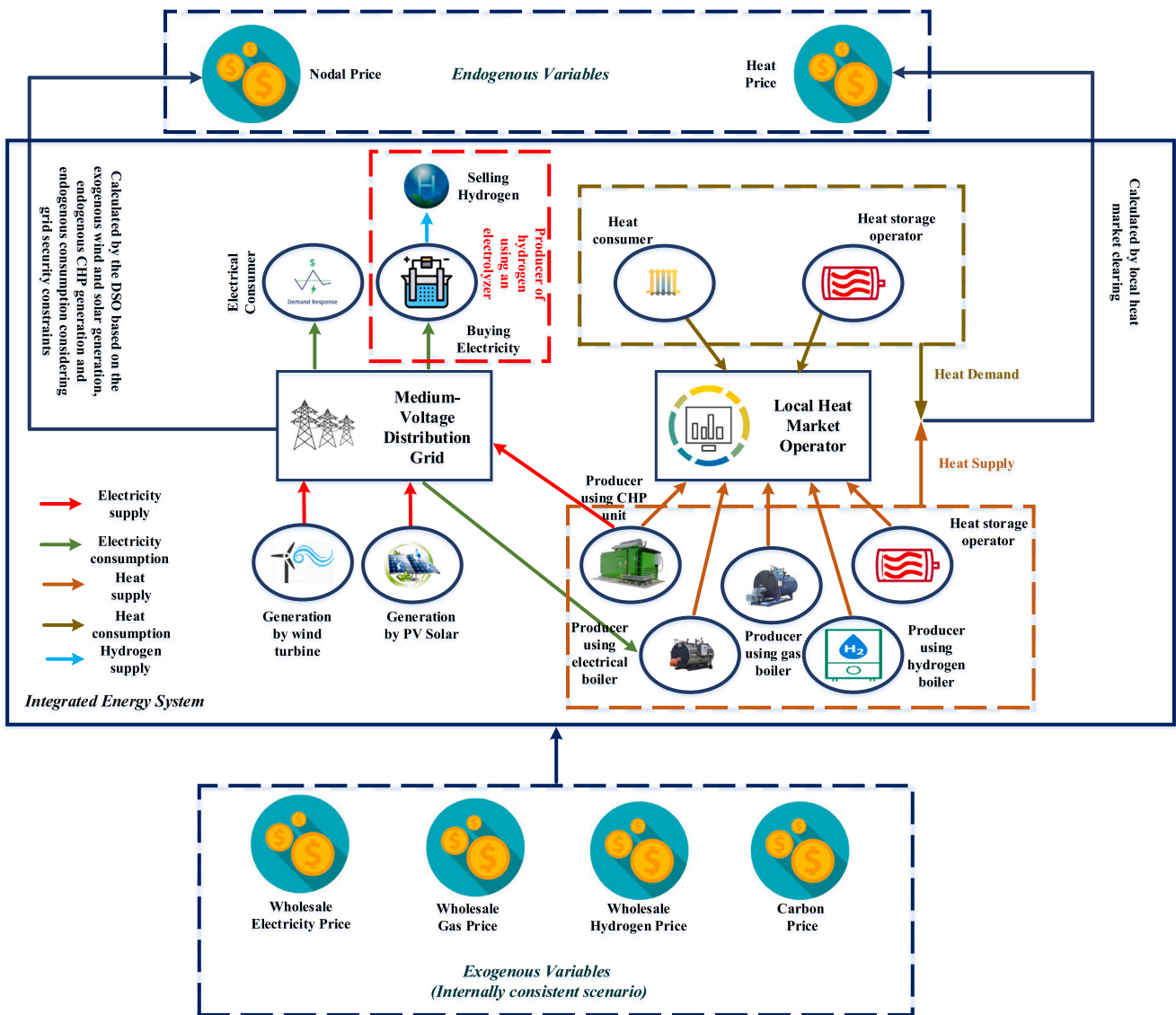

Fig. 1. The analytical framework of the integrated energy system model.

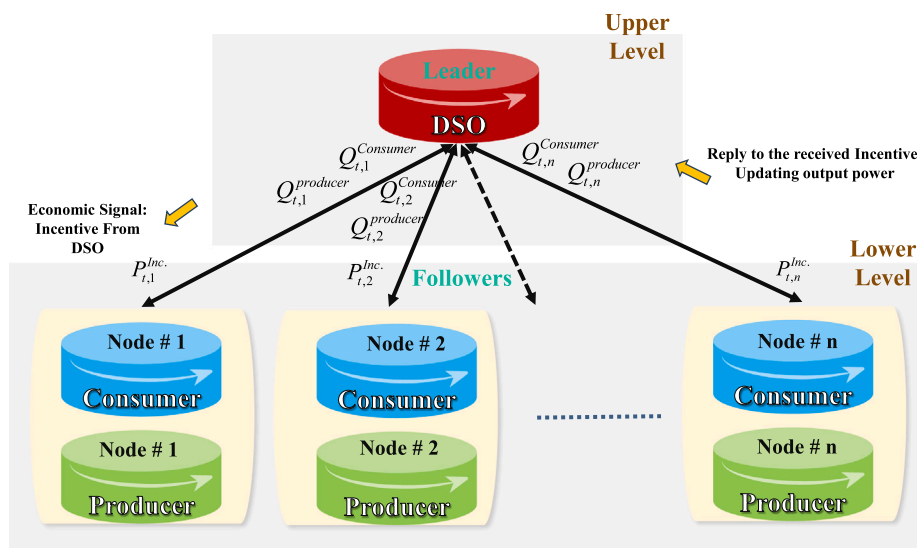

Fig. 2. The structure of the model for solving congestion in distribution grid.

$$Q_{Chp,n}^{\min} \leq Q_{Chp,n}^{Chp,E} \leq Q_{Chp,n}^{\max} : \chi_{n,t}^{Chp,4^-}, \chi_{n,t}^{Chp,4^+} \quad (14)$$

$$Q_{n,t}^{Chp,E} - Q_{n,t-1}^{Chp,E} \leq \text{Ramp}_{Chp,n}^{\text{Up}} \Delta t : \chi_{n,t}^{Chp,5} \quad (15)$$

$$Q_{n,t-1}^{Chp,E} - Q_{n,t}^{Chp,E} \leq \text{Ramp}_{Chp,n}^{\text{Down}} \Delta t : \chi_{n,t}^{Chp,6} \quad (16)$$

As depicted in Eq. (10), objective function includes five terms. The cost of buying natural gas, producing carbon emissions, and operating the unit have been expressed in the first, second, and third terms, respectively. In addition, the fourth and fifth terms express the unit's revenue from selling electrical and heat power. The amount of the consumed natural gas and the produced carbon are shown through Eqs. (11), and (12). According to this unit's power-to-heat ratio, the unit's heat production can be computed by Eq. (13). The maximum and minimum permissible amounts for producing power have been forced through Eq. (14). The last two equations focus on such units' ramp-up and ramp-down limitations. According to the time-frame of applying this model (after day-ahead market), the unit's start-up and shut-down times for the next 24 h are known. Therefore, it is possible to skip constraints for considering such limitations in this model to have a linear optimization problem.

### 3.2.4. Producers operating the electrical boiler

The electrical boiler connects the electrical grid and the district heating system by converting electrical power to heat, increasing the electricity system's flexibility. The objective function of the producers operating this technology, accompanied by its operational constraints, is formulated as follows:

$$\text{O.F.} : \text{Min}_{\{Q_{n,t}^{EB,E}, Q_{n,t}^{EB,Heat}\}} \sum_{t=1} Q_{n,t}^{EB,E} P_{n,t}^{\text{Elec}} + \sum_{t=1} Q_{n,t}^{EB,Heat} P_{EB,n}^{\text{O\&M}} - \sum_{t=1} Q_{n,t}^{EB,Heat} P_t^{\text{Heat}} \quad (17)$$

$$Q_{n,t}^{EB,E} = Q_{n,t}^{EB,Heat} / \eta_n^{EB} : \chi_{n,t}^{EB,1} \quad (18)$$

$$Q_{EB,n}^{\min} \leq Q_{n,t}^{EB,Heat} \leq Q_{EB,n}^{\max} : \chi_{n,t}^{EB,2^-}, \chi_{n,t}^{EB,2^+} \quad (19)$$

$$Q_{n,t}^{EB,Heat} - Q_{n,t-1}^{EB,Heat} \leq \text{Ramp}_{EB,n}^{\text{Up}} \Delta t : \chi_{n,t}^{EB,3} \quad (20)$$

$$Q_{n,t-1}^{EB,Heat} - Q_{n,t}^{EB,Heat} \leq \text{Ramp}_{EB,n}^{\text{Down}} \Delta t : \chi_{n,t}^{EB,4} \quad (21)$$

The objective function involves the cost of buying electrical power from the grid, the operational cost, and the revenue obtained from selling the produced heat in the heat market. The first, second and third terms of Eq. (17) refer to them respectively. This unit's consumed electric power is related to its generated heat power through this technology's efficiency in Eq. (18). Eq. (19) limits the acceptable amount that this unit can produce per dispatch interval. Ramp-up and down limitations of the electrical boiler are shown in Eqs. (20) and (21) separately. Similar mathematical formulations are also applied for the heat pump in this model.

### 3.2.5. Producers operating the gas-fired district heating boiler

This boiler can produce heat by burning natural gas and producing carbon emissions. The objective function of producers operating this boiler along with operational limitations of this technology is expressed as follows:

$$\text{O.F.} : \text{Min}_{\{Q_{GB,n,t}^{\text{Gas}}, Q_{GB,n,t}^{\text{Carb}}, Q_{GB,n,t}^{\text{Heat}}\}} \sum_{t=1} Q_{GB,n,t}^{\text{Gas}} P_t^{\text{Gas}} + \sum_{t=1} Q_{GB,n,t}^{\text{Carb}} P_t^{\text{Carb}} + \sum_{t=1} Q_{GB,n,t}^{\text{Heat}} P_{GB,t}^{\text{O\&M}} - \sum_{t=1} Q_{GB,n,t}^{\text{Heat}} P_t^{\text{Heat}} \quad (22)$$

$$Q_{GB,n,t}^{\text{Gas}} = Q_{GB,n,t}^{\text{Heat}} / \eta_n^{\text{GB}} : \chi_{n,t}^{\text{GB},1} \quad (23)$$

$$Q_{GB,n}^{\min} \leq Q_{GB,n,t}^{\text{Heat}} \leq Q_{GB,n}^{\max} : \chi_{n,t}^{\text{GB},2^-}, \chi_{n,t}^{\text{GB},2^+} \quad (24)$$

$$Q_{GB,n,t}^{\text{Heat}} - Q_{GB,n,t-1}^{\text{Heat}} \leq \text{Ramp}_{GB,n}^{\text{Up}} \Delta t : \chi_{n,t}^{\text{GB},3} \quad (25)$$

$$Q_{GB,n,t-1}^{\text{Heat}} - Q_{GB,n,t}^{\text{Heat}} \leq \text{Ramp}_{GB,n}^{\text{Down}} \Delta t : \chi_{n,t}^{\text{GB},4} \quad (26)$$

As seen in Eq. (22), the cost of consuming natural gas as a fuel and producing carbon emissions as a consequence of burning natural gas, operational cost, and the revenue from selling the heat generation are involved in the objective function of this technology. Similar explanations have been done for Eqs. (18)–(21) are valid for Eqs. (23)–(26) as well.

### 3.2.6. Producers operating hydrogen boiler

This unit can produce the required heat by consuming hydrogen without causing air pollution. Technical constraints of this technology and the objective function of its producer can be stated as follows:

$$\text{O.F.} : \text{Min}_{\{Q_{HB,n,t}^{\text{H}_2}, Q_{HB,n,t}^{\text{Heat}}\}} \sum_{t=1} Q_{HB,n,t}^{\text{H}_2} P_t^{\text{H}_2} + \sum_{t=1} Q_{HB,n,t}^{\text{Heat}} P_{HB,t}^{\text{O\&M}} - \sum_{t=1} Q_{HB,n,t}^{\text{Heat}} P_t^{\text{Heat}} \quad (27)$$

$$Q_{HB,n,t}^{\text{H}_2} = Q_{HB,n,t}^{\text{Heat}} / \eta_n^{\text{HB}} : \chi_{n,t}^{\text{HB},1} \quad (28)$$

$$Q_{HB,n}^{\min} \leq Q_{HB,n,t}^{\text{Heat}} \leq Q_{HB,n}^{\max} : \chi_{n,t}^{\text{HB},2^-}, \chi_{n,t}^{\text{HB},2^+} \quad (29)$$

$$Q_{HB,n,t}^{\text{Heat}} - Q_{HB,n,t-1}^{\text{Heat}} \leq \text{Ramp}_{HB,n}^{\text{Up}} \Delta t : \chi_{n,t}^{\text{HB},3} \quad (30)$$

$$Q_{HB,n,t-1}^{\text{Heat}} - Q_{HB,n,t}^{\text{Heat}} \leq \text{Ramp}_{HB,n}^{\text{Down}} \Delta t : \chi_{n,t}^{\text{HB},4} \quad (31)$$

The cost of buying hydrogen, the operational cost and the revenue from selling the generated heat construct the objective function of this unit (Eq. (27)). The descriptions of Eqs. (28)–(31) are similar to what is mentioned for Eqs. (18)–(21).

### 3.2.7. Operators of heat storage

Heat storage can work as a buffer in a district heating system. This technology can store thermal energy at particular hours and then inject it into the heat network later when it is profitable. The optimization problem for the operator of this device, taking into account its operational constraints, is to minimize the net costs aggregated over a full day:

$$\text{O.F.} : \text{Min}_{\{Q_{ch,n,t}^{\text{HS}}, Q_{dch,n,t}^{\text{HS}}, SOC_{n,t}^{\text{HS}}\}} \sum_{t=1} Q_{ch,n,t}^{\text{HS}} P_t^{\text{heat}} + \sum_{t=1} Q_{ch,n,t}^{\text{HS}} P_{HS,n,t}^{\text{O\&M}} - \sum_{t=1} Q_{dch,n,t}^{\text{HS}} P_t^{\text{heat}} + \sum_{t=1} Q_{dch,n,t}^{\text{HS}} P_{HS,n,t}^{\text{O\&M}} \quad (32)$$

$$0 \leq Q_{ch,n,t}^{\text{HS}} \leq Q_{HS,n}^{\text{Cap}} : \chi_{n,t}^{\text{HS},1^-}, \chi_{n,t}^{\text{HS},1^+} \quad (33)$$

$$0 \leq Q_{dch,n,t}^{\text{HS}} \leq Q_{HS,n}^{\text{Cap}} : \chi_{n,t}^{\text{HS},2^-}, \chi_{n,t}^{\text{HS},2^+} \quad (34)$$

$$SOC_{n,t}^{\text{HS}} = SOC_{n,t-1}^{\text{HS}} + (Q_{ch,n,t}^{\text{HS}} \eta_{\text{ch}}^{\text{HS}} - Q_{dch,n,t}^{\text{HS}} / \eta_{\text{dch}}^{\text{HS}}) \Delta t \quad \forall t \geq 2 : \chi_{n,t}^{\text{HS},3} \quad (35)$$

$$SOC_{n,1}^{\text{HS}} = SOC_{\text{initial},n}^{\text{HS}} + (Q_{ch,n,1}^{\text{HS}} \eta_{\text{ch}}^{\text{HS}} - Q_{dch,n,1}^{\text{HS}} / \eta_{\text{dch}}^{\text{HS}}) \Delta t : \chi_{n,t}^{\text{HS},4} \quad (36)$$

$$SOC_{\text{min},n}^{\text{HS}} \leq SOC_{n,t}^{\text{HS}} \leq SOC_{\text{max},n}^{\text{HS}} : \chi_{n,t}^{\text{HS},5^-}, \chi_{n,t}^{\text{HS},5^+} \quad (37)$$

The objective function comprises four terms. The first and second terms show the cost of buying heat power from the heat market and the operation cost of charging the storage, respectively. In addition, the third and fourth terms emphasize the revenue of heat storage from selling the heat power to the market and its discharging cost. Limitations on maximum charging and discharging amount are considered through Eq. (33), and Eq. (34). The energy level of storage at each dispatch interval is updated using Eqs. (35) and (36). Finally, the permissible energy level of the storage is taken into account by Eq. (37).

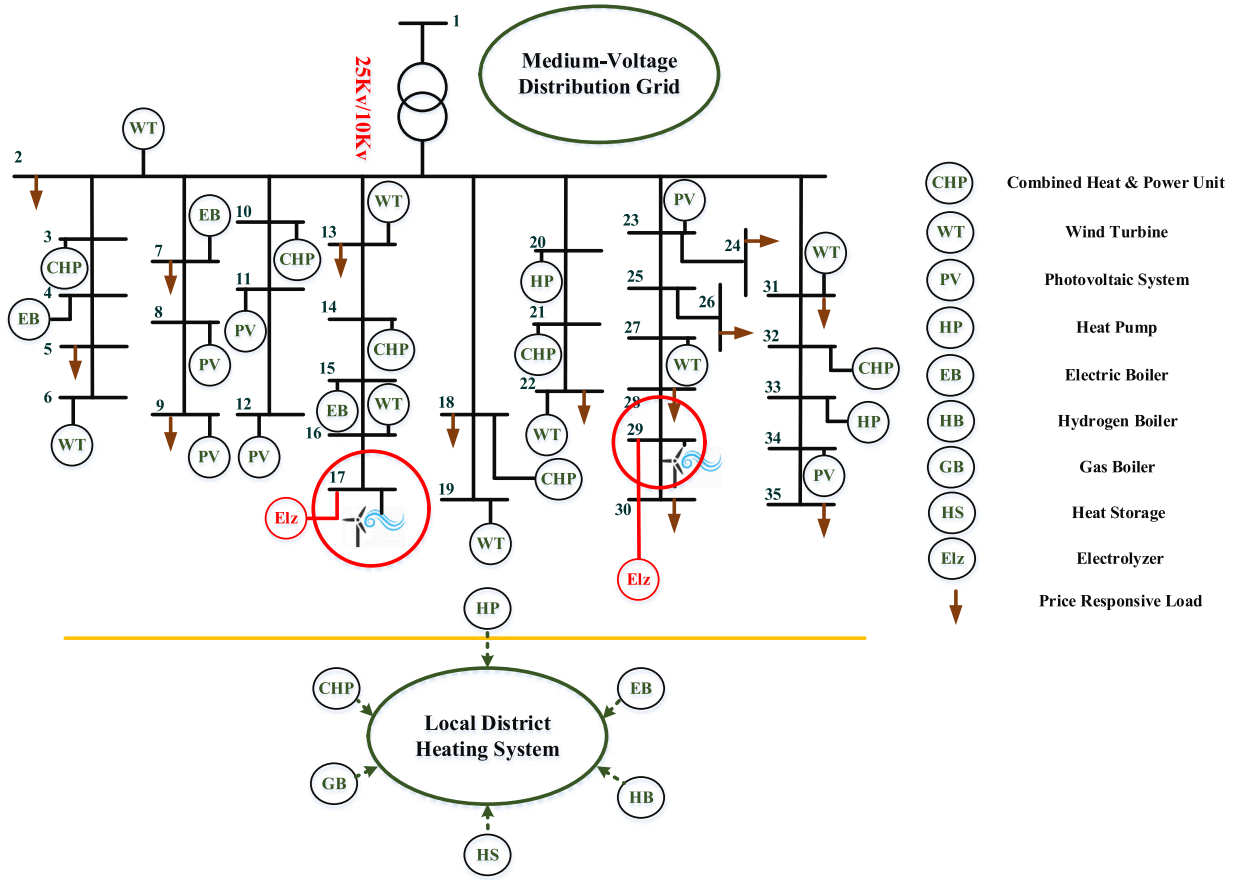

Fig. 3. A typical medium-voltage distribution grid in the Netherlands.

### 3.2.8. Medium-voltage distribution grid

As explained in the previous subsection, the key responsibility of DSOs is to assess whether technical and security constraints of the grid are violated according to the given generation and consumption patterns or not. The DSO can run the optimal power flow optimization problem after the day-ahead market to fulfill this aim. Results obtained from this optimization problem can signal the DSO about existing congestion in the grid. In order to have a convex OPF problem in this model, the simplified DistFlow method is applied [39] for formulating the technical and security constraints of the grid as follows:

$$\text{O.F. : } \min \{ Q_{l,t}^{\text{Loss}}, Q_{l,t}^{\text{Load}}, Q_{l,t}^{\text{Elz}}, Q_{l,t}^{\text{P2Heat}}, Q_{l,t}^{\text{Chp}}, Q_{l,t}^{\text{RW}}, Q_{l,t}^{\text{Curt}}, Q_{l,t}^{\text{Load}}, Q_{l,t}^{\text{Elz}}, Q_{l,t}^{\text{P2Heat}}, Q_{l,t}^{\text{Chp}}, Q_{l,t}^{\text{RW}}, Q_{l,t}^{\text{Curt}}, Q_{l,t}^{\text{Load}}, Q_{l,t}^{\text{Elz}}, Q_{l,t}^{\text{P2Heat}}, Q_{l,t}^{\text{Chp}}, Q_{l,t}^{\text{RW}}, Q_{l,t}^{\text{Curt}}, Q_{l,t}^{\text{Load}}, Q_{l,t}^{\text{Elz}}, Q_{l,t}^{\text{P2Heat}}, Q_{l,t}^{\text{Chp}}, Q_{l,t}^{\text{RW}}, Q_{l,t}^{\text{Curt}} \} \quad (38)$$

$$Q_{n,t}^{\text{Load}} + Q_{n,t}^{\text{Elz}} + Q_{n,t}^{\text{P2Heat}} - Q_{n,t}^{\text{Chp}} - Q_{n,t}^{\text{RW}} - Q_{n,t}^{\text{gen}} = Q_{l_{\text{back}(n),t}}^{\text{Line}} - \sum_{l \in \mathcal{H}(n)} Q_{l,t}^{\text{Line}} \quad : \lambda_{n,t} \quad (39)$$

$$q_{n,t}^{\text{Load}} - q_{n,t}^{\text{gen}} = q_{l_{\text{back}(n),t}}^{\text{Line}} - \sum_{l \in \mathcal{H}(n)} q_{l_{\text{ahead}(n),t}}^{\text{Line}} \quad : \phi_{n,t} \quad (40)$$

$$(V_{t,n}^{\text{back}})^2 - (V_{t,n}^{\text{ahead}})^2 = 2R_{\text{Line},l} Q_{t,l}^{\text{Line}} + 2X_{\text{Line},l} q_{t,l}^{\text{Line}} \quad : \gamma_{l,t} \quad (41)$$

$$Q_{n,t}^{\text{Load}} + Q_{n,t}^{\text{Load,shed}} = Q_{n,t}^{\text{Load,E}} \quad : \psi_{n,t}^{\text{Load,Q}} \quad (42)$$

$$q_{n,t}^{\text{Load}} = \frac{\sqrt{1 - (\cos(\phi))_{\text{Load}_n}^2}}{\cos(\phi)_{\text{Load}_n}} Q_{n,t}^{\text{Load}} \quad : \psi_{n,t}^{\text{Load,q}} \quad (43)$$

$$Q_{n,t}^{\text{Elz}} + Q_{n,t}^{\text{shed,Elz}} = Q_{n,t}^{\text{Elz,E}} \quad : \psi_{n,t}^{\text{Elz}} \quad (44)$$

$$Q_{n,t}^{\text{P2Heat}} + Q_{n,t}^{\text{shed,P2Heat}} = Q_{n,t}^{\text{EB,E}} \quad : \psi_{n,t}^{\text{P2Heat}} \quad (45)$$

$$Q_{n,t}^{\text{Chp}} + Q_{n,t}^{\text{Curt,Chp}} = Q_{n,t}^{\text{Chp,E}} \quad : \psi_{n,t}^{\text{Chp}} \quad (46)$$

$$Q_{n,t}^{\text{RW}} + Q_{n,t}^{\text{Curt,RW}} = Q_{n,t}^{\text{Exp}} \quad : \psi_{n,t}^{\text{RW}} \quad (47)$$

$$(V_{t,n}^{\text{min}})^2 \leq (V_{t,n})^2 \leq (V_{t,n}^{\text{max}})^2 \quad : v_{n,t}^-, v_{n,t}^+ \quad (48)$$

$$|S_{l,t}^{\text{Line}}| \leq |S_{l,t}^{\text{max}}| \quad (49)$$

As illustrated in Eq. (38), the DSO seeks to minimize his operational costs, including active power loss, load shedding cost, and generation curtailment cost. This method's active and reactive power balance at each grid node is formulated through Eqs. (39) and (40). Eq. (41) demonstrates voltage drop at each grid line according to power passing. The sum of the actual electrical power consumption by consumers and the load shedding must be equal to the required amount. This point is satisfied by Eq. (42). The next constraint shows the consumed reactive power of consumers. Eq. (44) emphasizes that sum of the actual power consumed by the electrolyzer at node  $n$  and load shedding amount must be equal to its requested amount. A similar concern is also valid for electrical boilers and heat pumps (See Eq. (45)). Eqs. (46) and (47) imply that the sum of the permitted injected power from CHP unit and renewables and the amount of generation curtailment must be equal to their expected output generation level. The next two equations demonstrate the security constraints of the grid. Eq. (48) points out that the voltage level at each grid node must be kept in the permissible



**Table 1**  
Technical and economic parameters of CHP units.

Node no.	Capacity MW	Efficiency %	O&M cost \$/kWh	Power-to-Heat –	Ramp rate MW/min
3	3.50	30	110	0.80	0.70
10	3.50	30	110	0.80	0.70
14	3.50	30	110	0.80	0.70
18	5.20	30	110	0.80	1.04
21	4.00	30	110	0.80	0.80
32	4.25	30	110	0.80	0.85

bound. In addition, Eq. (49) demonstrates that the apparent power passing through each line cannot exceeds its maximum level. As seen, all constraints are linear and convex except the last one. Hence, the last constraint can be replaced by four linear equations below to ensure that the OPT problem is convex [40].

$$Q_{l,t}^{Line} + q_{l,t}^{Line} \leq \sqrt{2S_l^{\max}} : \omega_{l,t}^1 \quad (50)$$

$$Q_{l,t}^{Line} - q_{l,t}^{Line} \leq \sqrt{2S_l^{\max}} : \omega_{l,t}^2 \quad (51)$$

$$-Q_{l,t}^{Line} + q_{l,t}^{Line} \leq \sqrt{2S_l^{\max}} : \omega_{l,t}^3 \quad (52)$$

$$-Q_{l,t}^{Line} - q_{l,t}^{Line} \leq \sqrt{2S_l^{\max}} : \omega_{l,t}^4 \quad (53)$$

Finally, according to the fact that in the radial distribution grid voltage level is approximately near 1, the active power loss can be formulated as follows in order to avoid non-convexity in the objective function [39].

$$Q_{l,t}^{Loss} = R_{Line,l} \frac{(Q_{l,t}^{Line})^2 + (q_{l,t}^{Line})^2}{(V_{l,t}^{head})^2} \approx R_{Line,l} [(Q_{l,t}^{Line})^2 + (q_{l,t}^{Line})^2] \quad (54)$$

Finally, the DSO can compute each node's nodal price according to the optimization mentioned above. As known, nodal price comprises three terms: electricity price, congestion price, and loss price. The first term is known as resulting from the market clearing process. The latter two terms equal the dual variable associated with active power balance constraint (Eq. (39)). In the rest of this paper, the sum of the congestion and loss prices is named dynamic price.<sup>2</sup>

### 3.2.9. Local heat market

The proposed integrated energy system involves a decentralized district heating system where heat power generators can inject their production. Therefore, this model's heat price is computed endogenously through the local heat market. Like other energy markets, the intersection of demand and supply curves determines the heat price. In this regard, an inverse linear heat demand function has been utilized in this model to compute the local heat price at each dispatch interval as follows:

$$P_t^{Heat} = \alpha_t - \beta_t \times Q_{Cons,t}^{tot} \quad (55)$$

Finally, the heat price  $P_t^{Heat}$  clears the local heat market once the following constraint is satisfied.

$$Q_{Cons,t}^{tot} = \sum_n \left[ Q_{n,t}^{Chp,Heat} + Q_{n,t}^{EB,Heat} + Q_{GB,n,t}^{Heat} + Q_{HB,n,t}^{Heat} + Q_{dch,n,t}^{HS} - Q_{ch,n,t}^{HS} \right] \quad (56)$$

As seen in Eq. (56), the total heat production of generators must meet the total heat consumption at each dispatch interval.

<sup>2</sup> A variable mentioned after colon at each equation refers to the dual variable associated with that equation which is used in solving the model.

**Table 2**  
Technical characteristics of power to heat technologies.

Type Tech.	Location no.	Capacity MW	COP –	O&M cost Euro/MWh	Ramp rate MW/min
Electrical boiler	4	5.00	1	0.5	5.00
Electrical boiler	7	3.00	1	0.5	3.00
Electrical boiler	15	4.50	1	0.5	4.50
Heat pump	20	5.50	4	0.5	1.04
Heat pump	33	4.25	4	0.5	0.85

As declared, the DSO uses dynamic prices to give grid users incentives to adapt their behavior. These incentives consist of dynamic prices at each node. As a result, the Single-Leader-Multiple-Followers model can be formulated as follows as a bi-level programming problem<sup>3</sup>:

$$Model \begin{cases} \text{O.F. :} & \text{Eq. (38)} \\ \text{Constraints :} & \text{Eqs. (39)–(48), (50)–(56)} \\ Q_{n,t}^{Elz,E} : & \in \text{argmin[Eq. (1)]Eqs. (2)–(5)} \\ Q_{n,t}^{Chp,E}, Q_{n,t}^{Chp,Heat} : & \in \text{argmin[Eq. (10)]Eqs. (11)–(16)} \\ Q_{n,t}^{EB,E}, Q_{n,t}^{EB,Heat} : & \in \text{argmin[Eq. (17)]Eqs. (18)–(21)} \\ Q_{GB,n,t}^{Heat} : & \in \text{argmin[Eq. (22)]Eqs. (23)–(26)} \\ Q_{HB,n,t}^{Heat} : & \in \text{argmin[Eq. (27)]Eqs. (28)–(31)} \\ Q_{ch,n,t}^{HS}, Q_{dch,n,t}^{HS} : & \in \text{argmin[Eq. (32)]Eqs. (33)–(37)} \end{cases} \quad (57)$$

## 4. Description of case study

This section describes the case study to which our method is applied. This case study demonstrates a representative model of MVDN in the Netherlands. (See Fig. 3) [41]

As seen in Fig. 3, this case study involves different distributed flexible resources and price-responsive loads. In addition, this case study is upgraded through a district heating system to assess how flexibility in the heat market can affect the economic feasibility of electrolyzers in the grid.

In this simulation, the average electricity consumption is 28.78 MW, and the average heat consumption is assumed to be 100 MWh. In addition, the heat and electricity consumption profile factors are fitted to the Dutch situation. (See Fig. 4)

The Price elasticity for electrical and heat consumers is assumed to be  $-0.3$ . Table 1 demonstrates the technical and economic parameters of the CHP units.

The technical parameters of electrical boilers and heat pumps can be found in Table 2.

Apart from electrical boilers, gas and hydrogen boilers are assumed to generate heat in the considered district heating system. Both boilers efficiency is 87.5% in this simulation.

The electricity, gas, and hydrogen prices in the Netherlands for year 2019 has been considered in this simulation. (See Fig. 5. [42])

The case study involves two types of renewable energy sources: wind turbines (WTs) and Solar photovoltaic (PV). The installed capacity of WT and PV is assumed to 4 MW and 6 MW, respectively. Fig. 6 depicts their capacity factor in the Netherlands for one year.

This simulation uses an alkaline electrolyzer to convert power to hydrogen. This type of PtH conversion system's efficiency is assumed to be 75%, the capital expenditure is 1 million per MW, and the lifetime is 25 years. In this paper's economic evaluation, the discount rate is 2.5%

<sup>3</sup> Commercial solvers can solve the proposed bi-level problem once it is converted to a single-level optimization problem. This can be feasible by replacing the existing convex optimization problems at the lower level with their associated Karush Kuhn Tucker (KKT) conditions. More details about the solution method have been provided in supplemental document exists in "[www.shorturl.at/LTW57](http://www.shorturl.at/LTW57)".

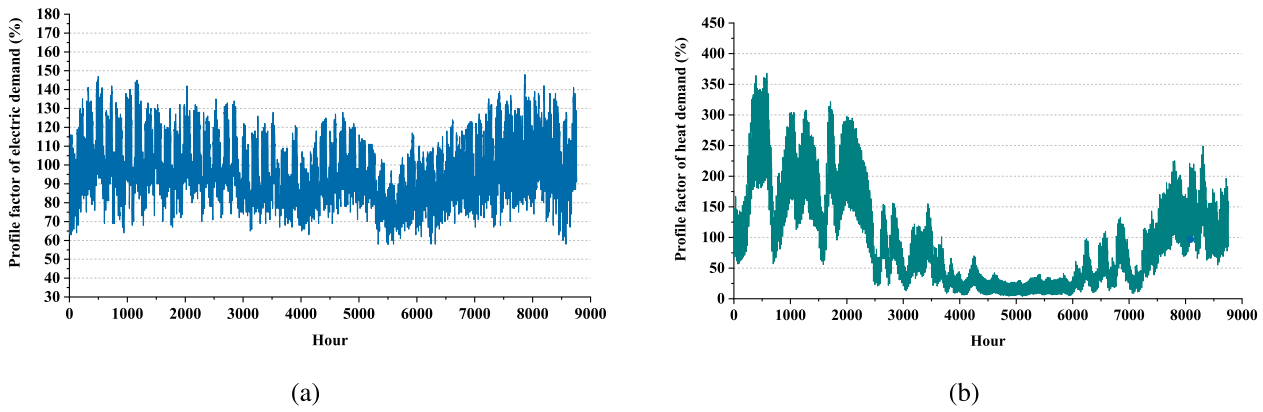

Fig. 4. Profile factors of electricity and heat consumption in the Netherlands.

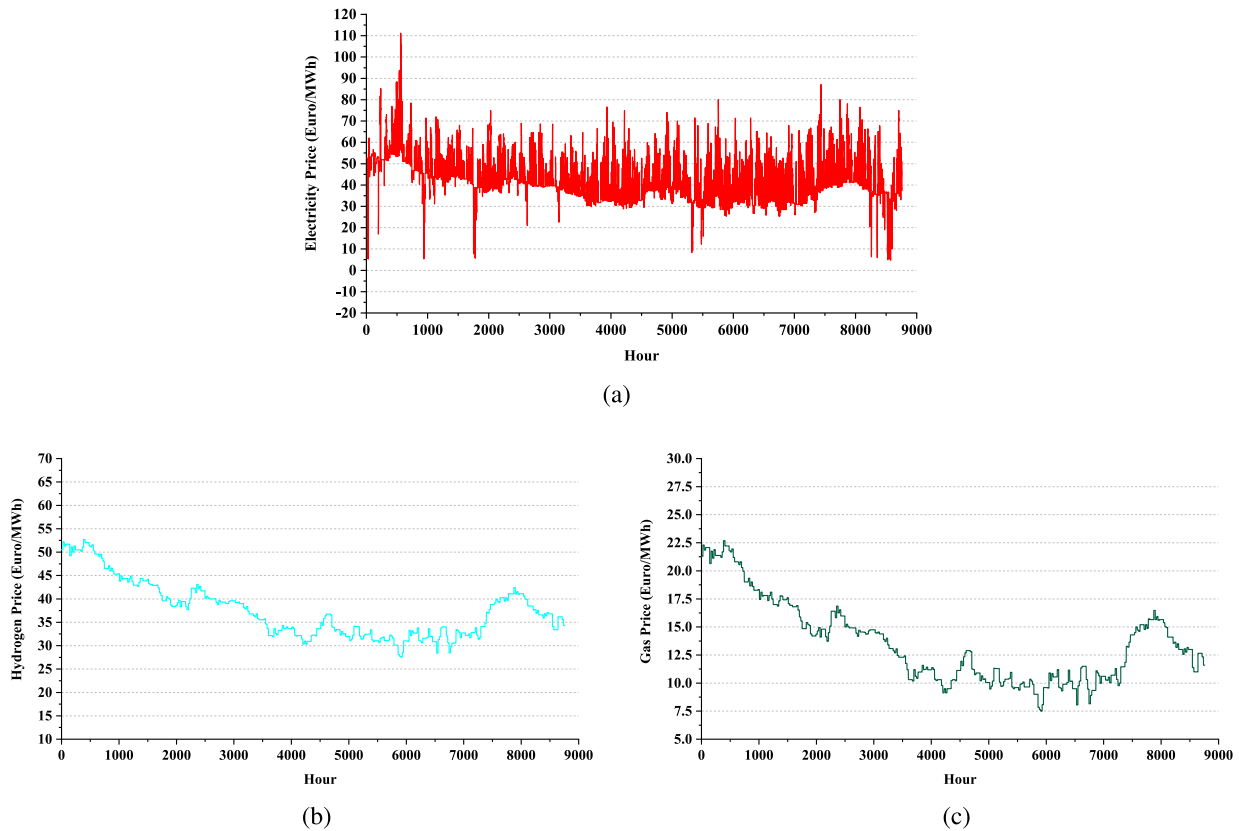

Fig. 5. Electricity, hydrogen, and gas prices in the Netherlands in 2019 [42].

as well. In addition, two nodes with the highest generation curtailment, 17 and 29, are locations for installing the electrolyzer.

### 5. Results of simulation

The results of the model analyses refer to the economic value of using electrolysers to provide flexibility to a grid operator. We analyze to what extent their operation can reduce network costs and improve the overall operating revenue of the integrated energy system.

In order to assess under which condition of the grid in terms of RES integration level, installing an electrolyzer can be profitable, calculation of a break-even point of that conversion system is necessitated. To reach this aim, the net yearly profit of the electrolyzer has to be computed according to the different scenarios for the penetration level of RES. In addition, the presence of flexibility providers besides

electrolyzers in the grid might increase the threshold for approval of being profitable in producing green hydrogen. Fig. 7, which involves two sub-figures for two different installed capacities of electrolyzer, provides a break-even point of both electrolyzers located at nodes 17 and 29. In addition, this figure accurately addresses what happens for the break-even point of electrolyzers after activating other grid users to participate in providing flexibility for the grid.

What stands out in both Figs. 7(a) and 7(b) is that the electrolyzer operation can be profitable once the integration level of RES is high enough. In addition, a break-even point for electrolyzers at different locations is not the same because of different grid situations in terms of consumption and generation patterns, the capacity of lines, and the type of installed technologies. Furthermore, there is a rise in the amount of the needed RES integration for making the electrolyzer break even in case of proposing incentives for all users. Because proposing

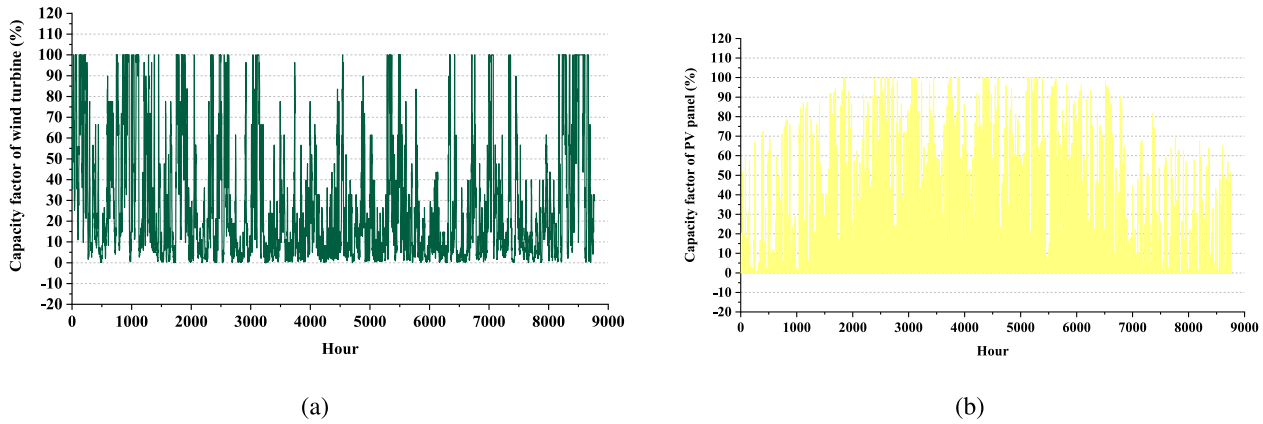

Fig. 6. Capacity factor of WT and PV in the Netherlands.

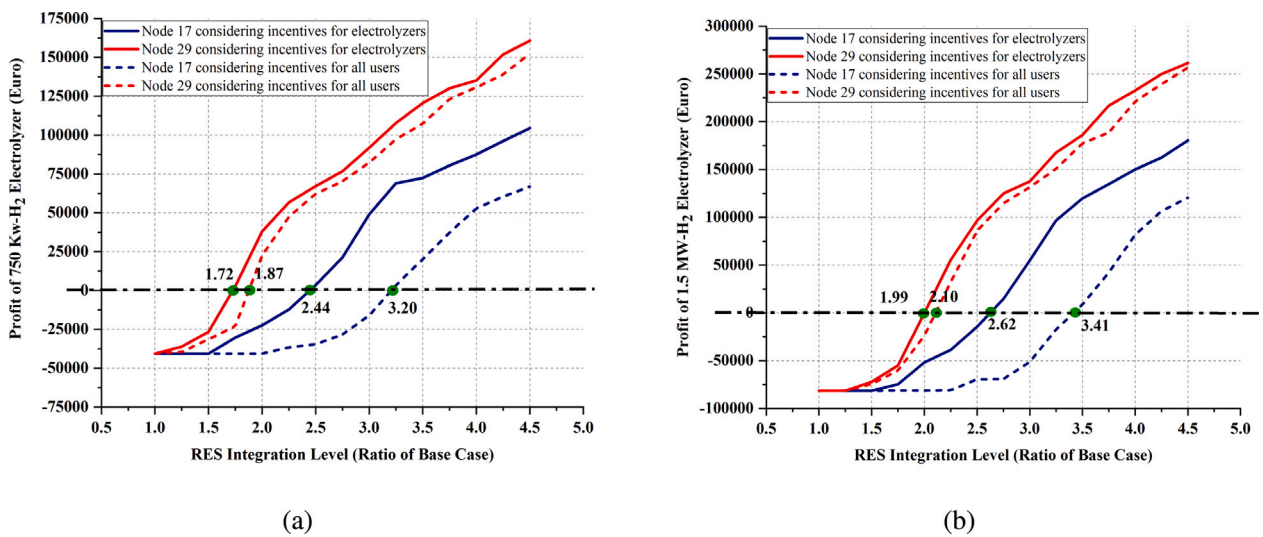

Fig. 7. A break-even point for electrolyzers at node 17 and 29.

incentives for all users provides more flexibility in the grid, a higher integration level of RES is demanded to make electrolyzers profitable. A closer inspection of both graphs shows that the intensity of the effect of proposing incentives for all users on the break-even point of the electrolyzer varies in different locations because of different conditions of the grid's feeders. Finally, as expected, in comparison between Figs. 7(a) and 7(b), it can be concluded that more RES integration level is required to justify electrolyzer operation with higher capacity due to its higher capital expenditures.

The type of renewable energy source installed close to the electrolyzer at the same node may affect the break-even point of that device. Fig. 8 demonstrates how replacing WT with PV at the location of the electrolyzer can change its break-even point.

In this analysis, 4-MW WT with an average capacity factor of 0.2766 is compared with 8.475-MW PV with an average capacity factor of 0.1306. As seen both renewable resources have the same energy production within a one year. According to the results in Fig. 8, at the particular grid location, different types of renewable energy resources result in different break-even points for electrolyzers. It is seen that the break-even point has declined once the PV system is installed. The main reason is related to the fact that the typical day solar irradiance pattern is different from the wind speed pattern. The amount of generation curtailment and its frequency are high in the case of the PV

system. Therefore, the operation hours of the electrolyzer increase and a break-even point decreases.

Fig. 9 illustrates how incentives in medium-voltage distribution grids are successful in activating electrolyzer to be operated.

As seen in Fig. 9, without incentive, the electric market price at each dispatch interval is higher than the marginal price for the electrolyzer. Therefore, it is not profitable for the electrolyzer to be operated. However, during the hours that grid suffers from the generation curtailment, the amount of the dynamic prices is negative. Consequently, the proposed electricity price for the electrolyzer is lower than the marginal price. Thus, the operation of the electrolyzer becomes reasonable.

Table 3 presents the number of required operation hours and average proposed dynamic price for electrolyzer at its break-even point per different scenarios of installed capacity and number of flexibility providers.

It is apparent from this table that dynamic prices vary between different nodes of the grid because of different conditions of the grid's feeders. According to the results demonstrated in this table, the absolute value of the average proposed dynamic price is reduced when incentives are provided for all users. Because once providers of flexibility in the grid are high, the DNO has more options for solving congestion in the grid. Hence, its reliance on electrolyzers reduces, and its offered incentive drops. In this situation, the electrolyzer requires more operation hours for being cost. Finally, as projected, an

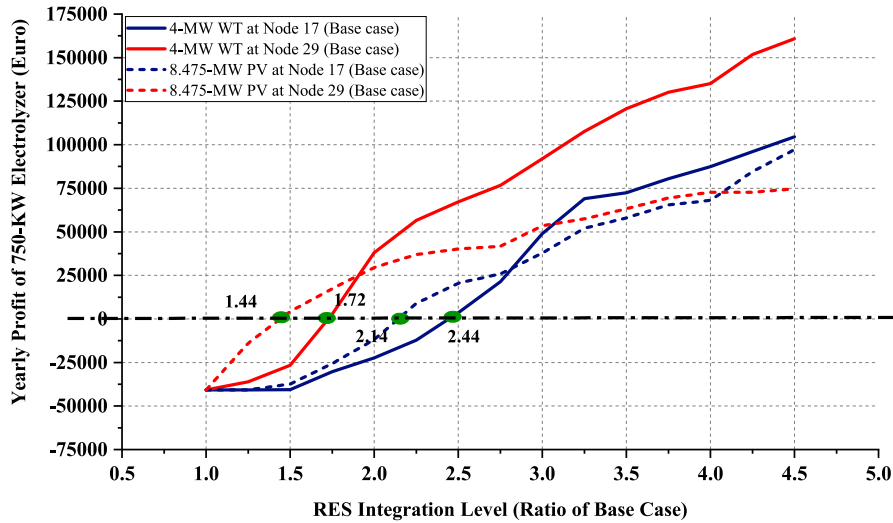

Fig. 8. Break-even point of electrolyzer per different type of renewable sources.

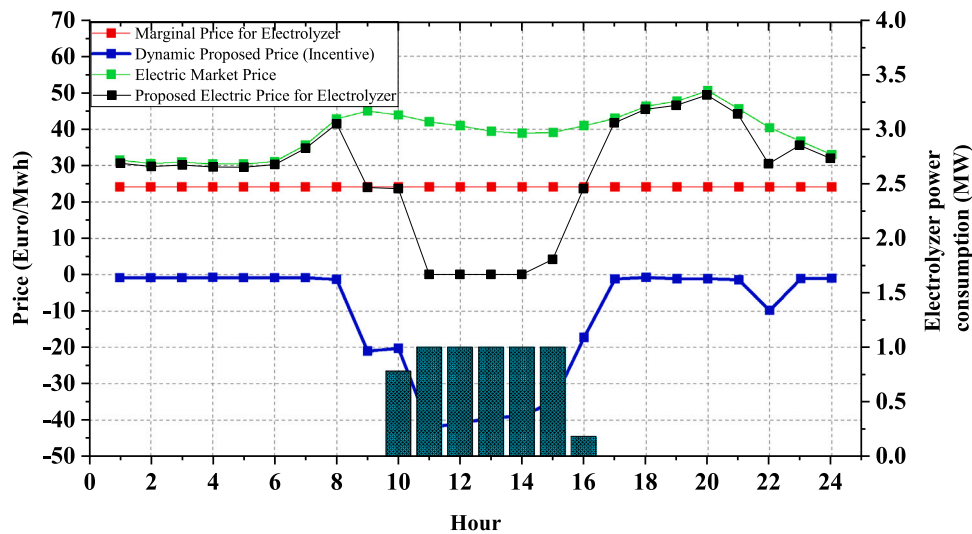

Fig. 9. Consumption power of electrolyzer, proposed incentive, and electric market price for a particular day.

Table 3

Number of required operation hours and average dynamic price for electrolyzer for being profitable.

Capacity of electrolyzer (MW)	Receivers of incentives	Node no.	Operation hours	Average dynamic price (Euro/MWh)
0.75	Electrolyzer	17	1736	-41.15
	Electrolyzer	29	2683	-34.74
	All users	17	2808	-30.67
	All users	29	2899	-31.82
1.50	Electrolyzer	17	2530	-36.76
	Electrolyzer	29	3393	-31.46
	All users	17	3269	-29.40
	All users	29	34.24	-30.66

electrolyzer with higher capacity at the particular node needs more operation hours to be profitable.

In order to assess the impact of different electrolyzer capacities at different nodes on the network and system costs, a sensitivity analysis is performed (see Fig. 10). The system cost in this analysis includes network costs and the electrolyzer net cost.

The dashed red and blue lines in Fig. 10 show that the network cost decreases by increasing the electrolyzer capacity installed at both

nodes 17 and 29. However, the optimal capacity of the electrolyzers from a network perspective is different from the one from a system perspective (solid red and blue lines). Although a larger electrolyzer adds extra costs to its net annual cost despite reducing generation curtailment costs for the grid, installing an electrolyzer can help to a certain extent to reduce the cost of the system. In addition, the location where the electrolyzer is installed can significantly influence the system cost. Fig. 10 illustrates that installing the electrolyzer at node 29 can result in a greater reduction in system costs than installing the electrolyzer at node 17. The explanation for this is that at node 29 generation curtailment exceeds the one at node 17.

As shown in Fig. 10, when the minimum system cost is met for both nodes 17 and 29, the electrolyzer's net cost is positive. Accordingly, the owner of the electrolyzer does not consider investing in such a technology, unless an extra financial revenue for operating the electrolyzer is received. In theory, such an extra revenue can be obtained by negotiation with the grid operator because it reduces total system costs. In addition, the profitability of an investment in an electrolyzer also depends on the hydrogen price. Therefore, a sensitivity analysis was also performed to assess how the hydrogen price affects the net annualized cost of the electrolyzer with 1.5 MW capacity at node 17 (see Fig. 11)

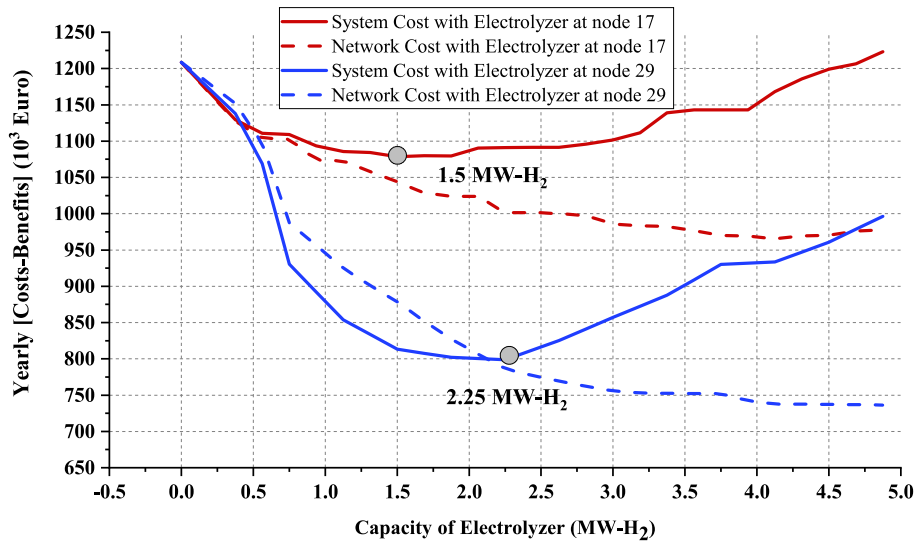

Fig. 10. Network cost and system cost for various levels of installed capacities of electrolyzers at nodes 17 and 29.

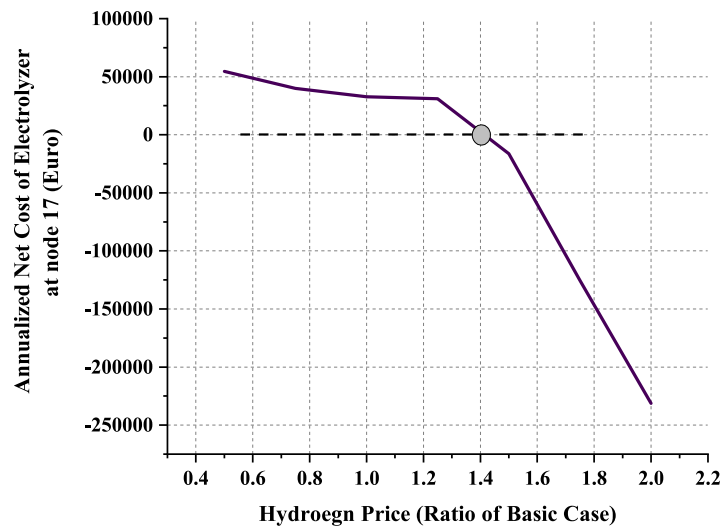

Fig. 11. Annualized net cost of electrolyzer at nodes 17 for various hydrogen prices.

It appears that the operation of the electrolyzer becomes profitable when the hydrogen price is significantly higher than the level assumed in the base case, as is shown in Fig. 11. When hydrogen becomes 1.4 times more expensive than the assumed price in the base case, the electrolyzer can be operated without an extra financial revenue from the grid operator.

The effectiveness of converting power to hydrogen through an electrolyzer in reducing system cost has been compared with the ability to convert power to heat through an electric boiler in Fig. 12. In order to make a fair comparison, the electrolyzer at node 17 is replaced by the electrical boiler.

What stands out in this Fig is the high impact of converting power to heat on reducing the system cost. As seen, at the optimal capacity for both technologies, the effectiveness of the electric boiler in reducing system cost is high. Low capital expenditure, high efficiency, and the difference between hydrogen and heat prices can be critical factors for justifying why converting power to heat through electrical boiler results in more reduction in the system cost.

Table 4 provides the net yearly operation revenue of grid users in three different cases in terms of proposing incentive and installing electrolyzer.

As can be seen from Table 4, some grid users benefit from proposing incentives and installing electrolyzers in the grid, and some lose. However, the overall improvement is positive. Incentives in the grid result in less generation curtailment and, consequently, less operation cost for the network operator. In addition, installing an electrolyzer plays a positive role in improving flexibility in the grid. Hence, considering both incentive and electrolyzer in the grid leads to more reduction in the network cost. However, the revenue of CHP units has decreased. This can be justified by this point that the value of proposed dynamic prices are mostly negative because of the high surplus generation of renewables. The arbitrage strategy of heat storage leads to gaining more benefits after proposing incentives. Because proposing incentives makes more difference in heat prices during 24 h. The negative value of dynamic prices results in lower operating costs of electric boilers, consequently increasing their revenue. As seen in Table 4, adding an electrolyzer to the grid can reduce the electric boiler's revenue by adding more flexibility providers to the grid. A similar justification is also valid for the change in the revenue of electrical consumers. The negative value of dynamic prices implicitly affects gas boilers' revenue. Such incentives influence heat prices. The average heat price during operation hours of gas boilers has increased. So, the revenue of gas

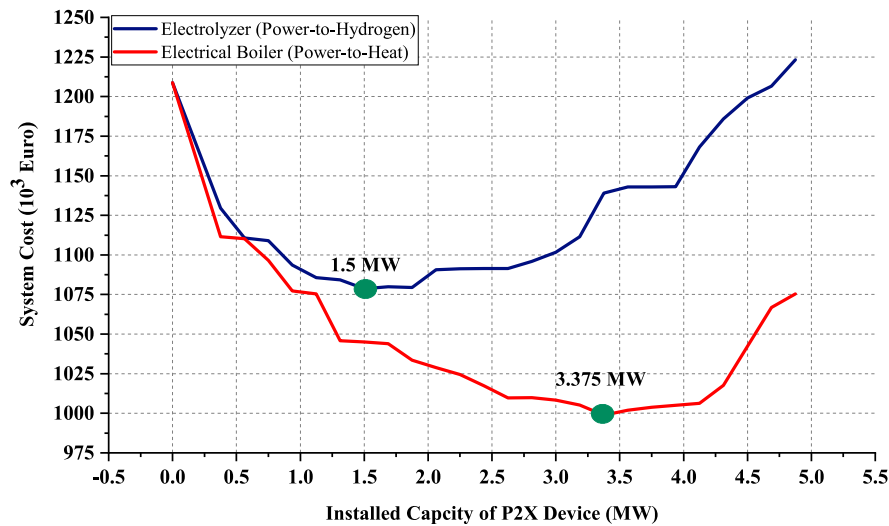

Fig. 12. System cost per different conversion technology.

Table 4

Net yearly operation revenue of grid users.

Item	Initial case	Case 1		Case 2	
	without incentive without electrolyzer 10 <sup>3</sup> Euro	With incentive without electrolyzer 10 <sup>3</sup> Euro	Improvement %	With incentive with electrolyzer 10 <sup>3</sup> Euro	Improvement %
Network	-1 208	-828	31.46	-560	53.62
CHP units	617	456	-26.10	456	-26.05
Renewables	13 898	13 898	00.00	13 898	00.00
Electrical consumers	18 301	18 933.05	03.44	18 775	02.58
Electrical boilers	78	132	69.02	120	53.85
Heat storage	6	6	05.36	6	04.63
Gas boiler	6 832	6909	01.12	6 909	01.12
Hydrogen boiler	35	29	-16.25	29	-15.95
Heat pumps	1 491	1513	01.46	1 513	01.47
Heat consumers	24 957	24 874	-00.33	24 873	-00.33
Electrolyzers	0	0	00.00	113	00.00
Total	65 010	65 925	01.40	66 137	01.73

boilers has increased. However, the average heat price during operation hours of hydrogen boilers has decreased. Thus, the revenue of hydrogen boilers has decreased. The operation of electrolyzer has a slight effect on their revenue. Finally, proposing incentives in distribution grids and operating electrolyzers slightly affect heat consumers' revenue. Sometimes, they cause an increase in heat price and reduce consumers' revenue, and sometimes they lead to a decrease in heat price and increase in consumer revenue.

Offering incentives on distribution grids may affect local heat prices because of devices that provide sector coupling between the electrical grid and heat network, such as electrical boilers and CHP units. In addition, an increase in heat generation in the district heating system can influence the electric power consumption and generation in distribution grids, which may change the grid's required flexibility demand. Thus, it can be expected that the change in heat production can also implicitly alter the break-even point of the electrolyzer.

Fig. 13 shows the difference in heat prices after proposing incentives for a specific day during four of the coldest months of the year, December, January, February, and March when heat consumption is high.

As seen in Fig. 13, local heat prices are sensitive to the proposed incentives in the electrical grid. It is seen that heat prices have been changed during the times in which the grid suffers from congestion. Because in those dispatch intervals, the incentive amount is not zero, which affects the marginal cost of heat generators.

As depicted, proposing incentives in the medium voltage distribution grid can influence local heat prices in both incremental and

Table 5

Amount of generated heat power (P.U.) at 10:00 on a particular day in December.

Technology	Without incentive	With incentive	% of increase in generation
Gas boiler	1.83	1.83	0.00
CHP unit	0.30	0.18	-41.62
Electrical boiler	0.00	0.04	-
Heat pump	0.16	0.16	0.00
Heat storage	0.00	0.00	0.00
Hydrogen boiler	0.00	0.00	0.00
Total generation	2.30	2.21	-3.80

decremented directions. However, it would be interesting to assess at which condition incentive's effect results in a rise in the amount of heat price and when it causes a drop. To fulfill this aim, two particular hours, namely 10:00 on a particular day in December and noon on a particular day in January, are selected for further analysis. Table 5 presents the amount of generated heat through heat generators with and without proposing incentives at 10:00 on a particular day in December.

According to the obtained results in Table 5, there is no change in the output power of gas boilers and heat pumps because of their lower marginal cost for generating heat. We can see that the output heat generation of CHP units has decreased during this time after receiving the dynamic price. However, the role of dynamic price on activating electrical boiler is positive. As seen, the total heat generation at this time after receiving the dynamic price has reduced. Therefore, the heat

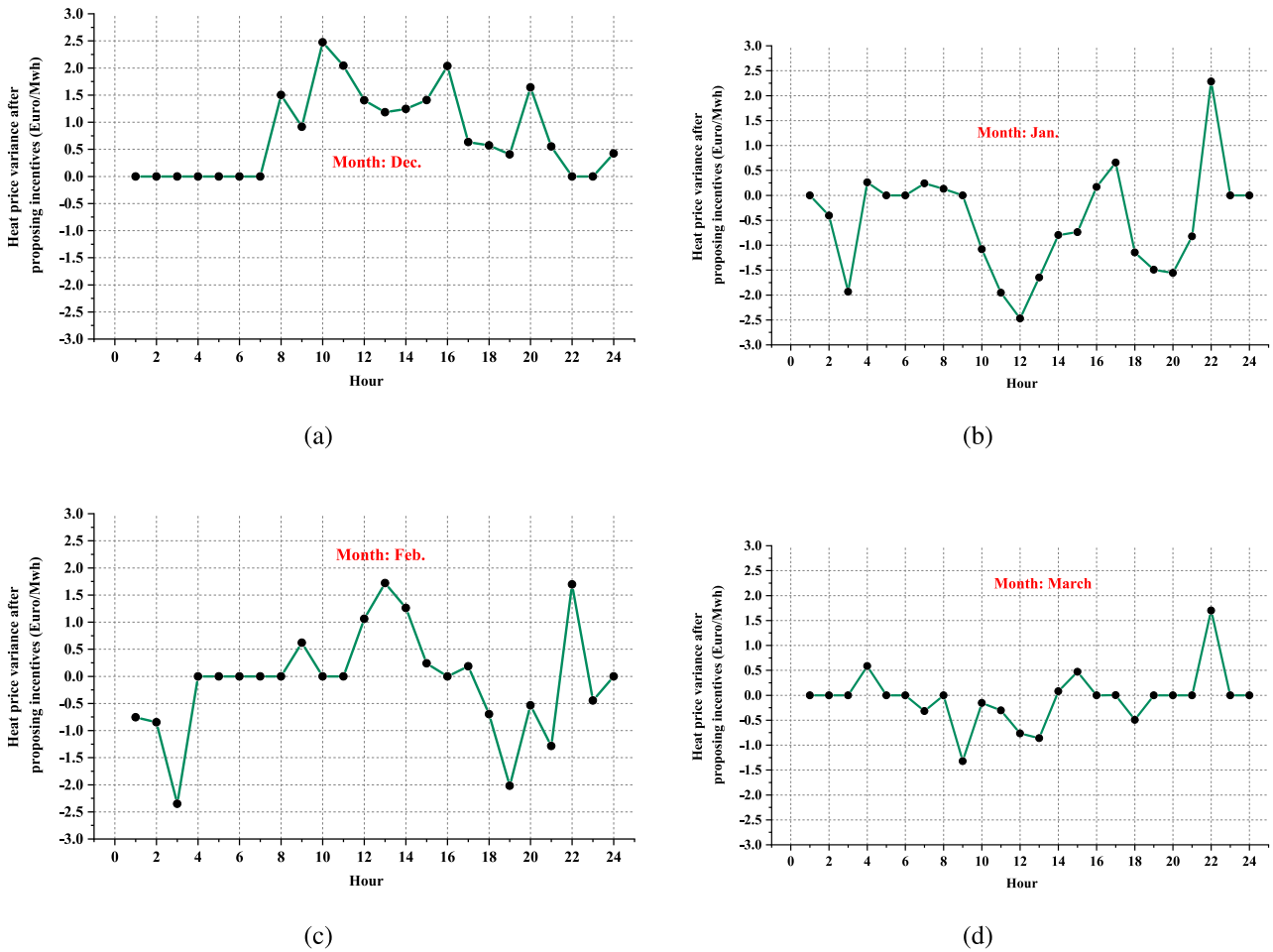

Fig. 13. Difference of heat price with initial value for a specific day during four of the coldest months.

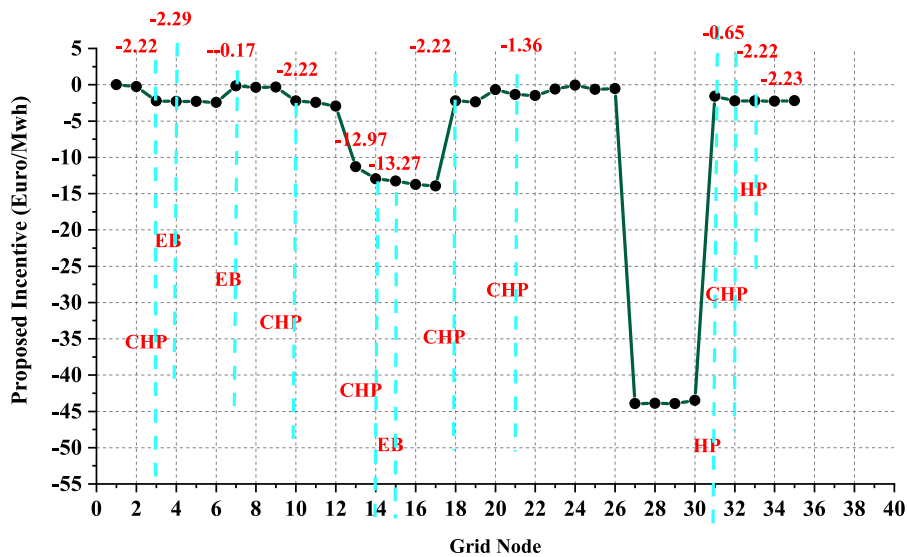

Fig. 14. Dynamic price at different grid nodes at 10:00.

price has risen. The heat price without incentive was 28.19 Euro/Mwh, which was determined by the CHP unit's marginal cost. However, with the incentive price, this price has gone up to 30.66, which is determined by the marginal cost of the electric boiler. Fig. 14 shows dynamic prices at different grid nodes at 10:00.

As seen in Fig. 14, most of the nodes where heat generators have been located are facing negative dynamic prices, which means a lower electricity price in those nodes. Therefore, the obtained revenue of CHP units reduces, and so they are not willing to generate more heat. However, this reduction in electricity price causes an increase in the

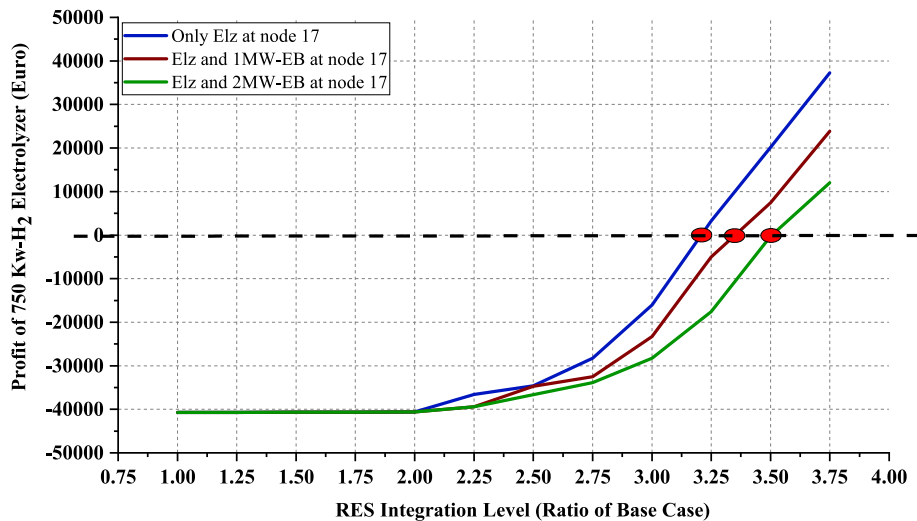

Fig. 15. Break-even point for the electrolyzer at node 17 with and without electrical boiler.

Table 6

Amount of generated heat power (P.U.) at noon of a particular day in January.

Technology	Without incentive	With incentive	% of increase in generation
Gas boiler	1.83	1.83	0.00
CHP unit	0.35	0.33	-6.26
Electrical boiler	0.00	0.12	1919.04
Heat pump	0.16	0.16	0.00
Heat storage	0.00	0.00	0.00
Hydrogen boiler	0.19	0.1795	-6.31
Total generation	2.55	2.63	3.37

heat production of electrical boilers. Without incentives, their marginal cost was high, and it would not be an economical option for generating heat. After receiving the dynamic price, their marginal cost reduces in this new condition, and they are selected as candidate devices for generating heat.

Table 6 displays the amount of generated heat through heat generators with and without proposing incentives at noon of a particular day in January.

The heat price in this dispatch interval without incentives in the grid is 60.58 Euro/MWh. Indeed, the marginal cost of an electrical boiler determines this price. However, it is seen that proposing incentives in the MVDN causes a reduction in the total generation of CHP units and a significant increase in the total generation of electrical boilers. Such modification resulted in a 3.37% increase in the total amount of generated heat, which reduced the heat price. After proposing the incentive, heat prices reduce to 58.11 Euro/MWh. Indeed the marginal cost of a hydrogen boiler determines the heat price at this time. Finally, what is striking about this analysis is that when the increased power of electric boilers compensates for the reduced power of CHP units, heat price reduces, and when an increased power of electrical boilers does not compensate for the reduced power of CHP units, the heat price increases.

As mentioned, the electrical boiler can act as a flexibility provider for the grid in case of suffering from high generation curtailment because an increase in the heat generation of the electrical boiler results in more electrical power consumption in the medium voltage distribution grid. In addition, a break-even point of the electrolyzer is likely changed by generating more heat in the district heating system through an electric boiler. To fulfill this point, two scenarios, namely adding an electrical boiler with a capacity of 1MW and adding an electrical boiler with a capacity of 2 MW near the electrolyzer, have been considered. Fig. 15 compares the break-even point of the electrolyzer in those

scenarios with the case in which there is no electrical boiler near the electrolyzer at node 17.

What stands out in the figure is that the break-even point of the electrolyzer increases after adding an electrical boiler near that conversion technology. As expected, the operation of the electric boiler results in more electrical consumption, and this provides flexibility for the grid in case of suffering from generation curtailment. When the number of flexibility providers increases, the electrolyzer needs more operation hours to be cost-effective. Hence, the break-even point increases in terms of the required renewables.

## 6. Conclusion

This paper investigated the economic feasibility of converting power to hydrogen to reduce congestion in medium-voltage distribution grids in the presence of high integration level of RES, price-responsive consumers, and a decentralized heat system. To fulfill this aim, a single-leader-multiple-followers game was developed to model an incentive-based method for improving flexibility in such grids. In this method, for every time unit dynamic congestion prices are determined for every node in the grid by the leader (i.e. the grid operator), and in response the followers (i.e. various price-responsive agents) adapt their production or consumption of electricity in order to maximize their objective functions (which generally consist of cost minimization).

Using exogenous prices for gas, electricity and hydrogen and various scenarios regarding the generation by renewables and load patterns, it appears that electrolyzers can operate profitably when they face dynamic congestion prices and the volume of renewable generation is high. Hence, producing green hydrogen through electrolysis in distribution grids can be an economically efficient method for solving congestion caused by high volumes of renewable generation. This also implies that installing an electrolyzer contributes to reducing the system's cost. Furthermore, this paper has shown that the economic value of electrolyzers as providers of flexibility depend on the presence of other flexible sources. When there are more price-sensitive consumers and producers, the economic value of electrolyzers decreases. The other sources of flexibility in distribution grids can come from heat producers, such as CHP and electrical boilers, which are also connected to the grid. When such heat producers are present, the direction of influence can also be the other way around. Hence, dynamic prices in the distribution grid can change the heat price because of their influence on the production of (some) heat producers. Because of the interaction between distribution grid and heat system, we find that the economic value of electrolyzers as providers of flexibility



also depends on events happening in the heat market. Overall, we conclude that by implementing dynamic grid prices, grid operators can encourage market parties to invest in power to hydrogen conversion systems in medium-voltage distribution networks which suffer from high generation curtailment. However, the capacity and place of installing such devices and the availability of flexibility providers in distribution networks can influence their competitiveness. To make investments in electrolysis profitable in distribution systems, high levels of RES are required, and this holds even stronger when other flexibility providers exist, such as those coming from a heat system. These findings provide essential insights regarding the potential role of grid incentives (i.e. dynamic prices) in motivating firms utilizing electrolyzers (and other flexible sources) to provide flexibility to the grid operator in order to solve congestion.

### CRedit authorship contribution statement

**Sina Ghaemi:** Conceptualization, Methodology, Software, Validation, Formal analysis, Investigation, Resources, Writing – original draft, Writing – review & editing, Visualization. **Xinyu Li:** Conceptualization, Methodology, Validation, Formal analysis, Investigation, Resources, Writing – review & editing, Visualization. **Machiel Mulder:** Conceptualization, Methodology, Formal analysis, Writing – review & editing, Supervision, Project administration, Funding acquisition.

### Declaration of competing interest

The authors declare that they have no known competing financial interests or personal relationships that could have appeared to influence the work reported in this paper.

### Data availability

Data will be made available on request.

### References

- [1] Kunz F. Improving congestion management: how to facilitate the integration of renewable generation in Germany. *Energy J* 2013;34(4).
- [2] Hirth L, Glismann S. Congestion management: From physics to regulatory instruments. 2018.
- [3] Poplavskaya K, Joos M, Krakowski V, Knorr K, De Vries L. Redispatch and balancing: Same but different. Links, conflicts and solutions. In: 2020 17th International conference on the european energy market (EEM). IEEE; 2020, p. 1–6.
- [4] Huang S, Wu Q, Liu Z, Nielsen AH. Review of congestion management methods for distribution networks with high penetration of distributed energy resources. In: IEEE PES innovative smart grid technologies. Europe: IEEE; 2014, p. 1–6.
- [5] Yan X, Gu C, Zhang X, Li F. Robust optimization-based energy storage operation for system congestion management. *IEEE Syst J* 2019;14(2):2694–702.
- [6] Bai L, Wang J, Wang C, Chen C, Li F. Distribution locational marginal pricing (DLMP) for congestion management and voltage support. *IEEE Trans Power Syst* 2017;33(4):4061–73.
- [7] Jafarian M, Scherpen JM, Loeff K, Mulder M, Aiello M. A combined nodal and uniform pricing mechanism for congestion management in distribution power networks. *Electr Power Syst Res* 2020;180:106088.
- [8] Zhang X, Liu Y, Zeng Y, Wu G, Liu J. Prosumer-centric energy storage system and high voltage distribution network topology Co-optimisation for urban grid congestion management. *IET Smart Grid* 2022.
- [9] Shen F, Wu Q, Jin X, Zhou B, Li C, Xu Y. ADMM-based market clearing and optimal flexibility bidding of distribution-level flexibility market for day-ahead congestion management of distribution networks. *Int J Electr Power Energy Syst* 2020;123:106266.
- [10] Asrari A, Ansari M, Khazaei J, Fajri P. A market framework for decentralized congestion management in smart distribution grids considering collaboration among electric vehicle aggregators. *IEEE Trans Smart Grid* 2019;11(2):1147–58.
- [11] Zhao J, Wang Y, Song G, Li P, Wang C, Wu J. Congestion management method of low-voltage active distribution networks based on distribution locational marginal price. *IEEE Access* 2019;7:32240–55.
- [12] Deb S, Goswami AK, Harsh P, Sahoo JP, Chetri RL, Roy R, Shekhawat AS. Charging coordination of plug-in electric vehicle for congestion management in distribution system integrated with renewable energy sources. *IEEE Trans Ind Appl* 2020;56(5):5452–62.
- [13] Venegas FG, Petit M, Perez Y. Active integration of electric vehicles into distribution grids: Barriers and frameworks for flexibility services. *Renew Sustain Energy Rev* 2021;145:111060.
- [14] Esmat A, Usaola J, Moreno MÁ. Distribution-level flexibility market for congestion management. *Energies* 2018;11(5):1056.
- [15] Shen F, Wu Q, Huang S, Chen X, Liu H, Xu Y. Two-tier demand response with flexible demand swap and transactive control for real-time congestion management in distribution networks. *Int J Electr Power Energy Syst* 2020;114:105399.
- [16] Huang S, Wu Q. Dynamic subsidy method for congestion management in distribution networks. *IEEE Trans Smart Grid* 2016;9(3):2140–51.
- [17] Liu W, Wu Q, Wen F, Østergaard J. Day-ahead congestion management in distribution systems through household demand response and distribution congestion prices. *IEEE Trans Smart Grid* 2014;5(6):2739–47.
- [18] Steriotis K, Tsaousoglou G, Efthymiopoulos N, Makris P, Varvarigos EM. A novel behavioral real time pricing scheme for the active energy consumers' participation in emerging flexibility markets. *Sustain Energy, Grids Netw* 2018;16:14–27.
- [19] Shen F, Huang S, Wu Q, Repo S, Xu Y, Østergaard J. Comprehensive congestion management for distribution networks based on dynamic tariff, reconfiguration, and re-profiling product. *IEEE Trans Smart Grid* 2018;10(5):4795–805.
- [20] Hu J, Liu X, Shahidehpour M, Xia S. Optimal operation of energy hubs with large-scale distributed energy resources for distribution network congestion management. *IEEE Trans Sustain Energy* 2021;12(3):1755–65.
- [21] Luo E, Cong P, Lu H, Li Y. Two-stage hierarchical congestion management method for active distribution networks with multi-type distributed energy resources. *IEEE Access* 2020;8:120309–20.
- [22] Fattaheian-Dehkordi S, Tavakkoli M, Abbaspour A, Fotuhi-Firuzabad M, Lehtonen M. An incentive-based mechanism to alleviate active power congestion in a multi-agent distribution system. *IEEE Trans Smart Grid* 2020;12(3):1978–88.
- [23] Zhang C, Ding Y, Nordentoft NC, Pinson P, Østergaard J. FLECH: A danish market solution for DSO congestion management through DER flexibility services. *J Mod Power Syst Clean Energy* 2014;2(2):126–33.
- [24] Geschermann K, Moser A. Evaluation of market-based flexibility provision for congestion management in distribution grids. In: 2017 IEEE power & energy society general meeting. IEEE; 2017, p. 1–5.
- [25] Ciavarella R, Di Somma M, Graditi G, Valenti M. Congestion Management in distribution grid networks through active power control of flexible distributed energy resources. In: 2019 IEEE milan powertech. IEEE; 2019, p. 1–6.
- [26] Contreras D, Fischer N, Müller S, Rudion K, Frankenbach M, von Haken A, Surmann B. An iterative quota calculation method for congestion management and optimal grid utilization. *Electr Power Syst Res* 2022;212:108380.
- [27] Lewandowska-Bernat A, Desideri U. Opportunities of power-to-gas technology in different energy systems architectures. *Appl Energy* 2018;228:57–67.
- [28] Berger M, Radu D, Fonteneau R, Deschuyteneer T, Detienne G, Ernst D. The role of power-to-gas and carbon capture technologies in cross-sector decarbonisation strategies. *Electr Power Syst Res* 2020;180:106039.
- [29] Xiong B, Predel J, del Granado PC, Egging-Bratseth R. Spatial flexibility in redispatch: Supporting low carbon energy systems with Power-to-Gas. *Appl Energy* 2021;283:116201.
- [30] Balan OM, Buga M-R, Brunot A, Badea A, Froelich D. Technical and economic evaluation of Power-to-Gas in link with a 50 MW wind park. *J Energy Storage* 2016;8:111–8.
- [31] Qardran M, Abeysekera M, Chaudry M, Wu J, Jenkins N. Role of power-to-gas in an integrated gas and electricity system in Great Britain. *Int J Hydrogen Energy* 2015;40(17):5763–75.
- [32] De Corato A, Saedi I, Riaz S, Mancarella P. Aggregated flexibility from multiple power-to-gas units in integrated electricity-gas-hydrogen distribution systems. *Electr Power Syst Res* 2022;212:108409.
- [33] Henni S, Staudt P, Kandiah B, Weinhardt C. Infrastructural coupling of the electricity and gas distribution grid to reduce renewable energy curtailment. *Appl Energy* 2021;288:116597.
- [34] Mazza A, Salomone F, Arrigo F, Bensaid S, Bompard E, Chicco G. Impact of Power-to-Gas on distribution systems with large renewable energy penetration. *Energy Convers Manag* X 2020;7:100053.
- [35] Robinius M, Raje T, Nykamp S, Rott T, Müller M, Grube T, Katzenbach B, Küppers S, Stolten D. Power-to-Gas: Electrolyzers as an alternative to network expansion—An example from a distribution system operator. *Appl Energy* 2018;210:182–97.
- [36] Jaramillo LB, Weidlich A. Optimal microgrid scheduling with peak load reduction involving an electrolyzer and flexible loads. *Appl Energy* 2016;169:857–65.

- [37] El-Taweel NA, Khani H, Farag HE. Voltage regulation in active power distribution systems integrated with natural gas grids using distributed electric and gas energy resources. *Int J Electr Power Energy Syst* 2019;106:561–71.
- [38] Yue M, Lambert H, Pahon E, Roche R, Jemei S, Hissel D. Hydrogen energy systems: A critical review of technologies, applications, trends and challenges. *Renew Sustain Energy Rev* 2021;146:111180.
- [39] Baran ME, Wu FF. Network reconfiguration in distribution systems for loss reduction and load balancing. *IEEE Power Eng Rev* 1989;9(4):101–2.
- [40] Faqiry MN, Edmonds L, Zhang H, Khodaei A, Wu H. Transactive-market-based operation of distributed electrical energy storage with grid constraints. *Energies* 2017;10(11):1891.
- [41] Coster EJ. *Distribution grid operation including distributed generation*. Enschede: Printed By Ipskamp Drukkers; 2010, p. 205.
- [42] Li X, Mulder M. Value of power-to-gas as a flexibility option in integrated electricity and hydrogen markets. *Appl Energy* 2021;304:117863.